

REMOTE CONTROL RC-EXZ3A INSTALLATION MANUAL

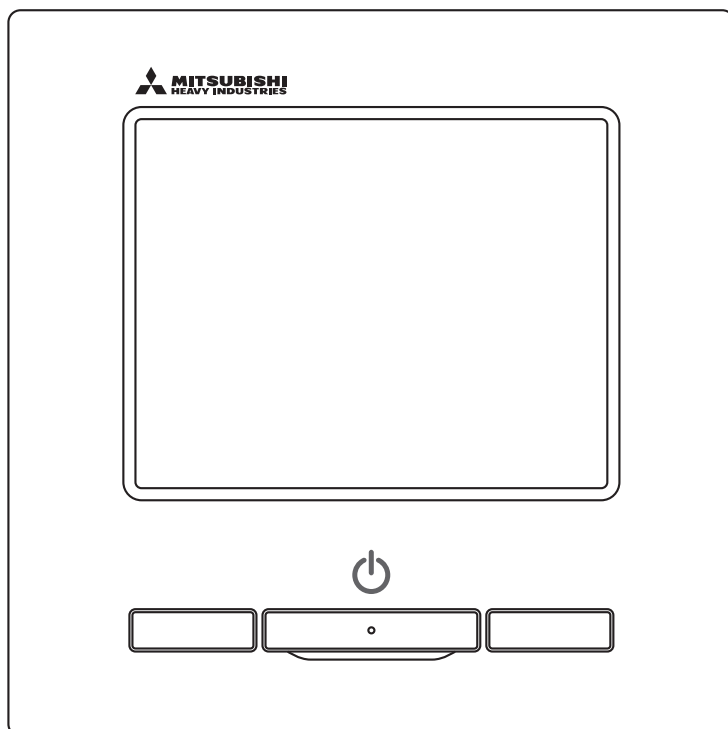

Contents

1. Safety precautions	4
2 . Accessories & Prepare on site.....	5
3. Installation place	6
4. Installation procedure	6
5. Main/Sub setting when more than one remote controls are used	8
6. Functions and menu items of the remote control	9
7. Main item	12
8. Power on and initial setting	14
9. Installation settings and test run	16
10. R/C function settings	20
11. IU settings	23
12. Service & Maintenance	31
13. Select the language	35

1. Safety precautions

• Please read this manual carefully before starting installation work to install the unit properly.

Every one of the followings is important information to be observed strictly.

⚠ WARNING Failure to follow these instructions properly may result in serious consequences such as death, severe injury, etc.















⚠ CAUTION Failure to follow these instructions properly may cause injury or property damage.

It could have serious consequences depending on the circumstances.

• The following pictograms are used in the text.

	Never do.		Always follow the instructions given.
--	-----------	---	---------------------------------------

• Keep this manual at a safe place where you can consult with whenever necessary. Show this manual to installers when moving or repairing the unit. When the ownership of the unit is transferred, this manual should be given to a new owner.

⚠ WARNING	
	<ul style="list-style-type: none"> • Consult your dealer or a professional contractor to install the unit. Improper installation made on your own may cause electric shocks, fire or dropping of the unit.
	<ul style="list-style-type: none"> • Installation work should be performed properly according to this installation manual. Improper installation work may result in electric shocks, fire or break-down.
	<ul style="list-style-type: none"> • Be sure to use accessories and specified parts for installation work. Use of unspecified parts may result in drop, fire or electric shocks.
	<ul style="list-style-type: none"> • Install the unit properly to a place with sufficient strength to hold the weight. If the place is not strong enough, the unit may drop and cause injury.
	<ul style="list-style-type: none"> • Be sure to have the electrical wiring work done by qualified electrical installer, and use exclusive circuit. Power source with insufficient and improper work can cause electric shock and fire.
	<ul style="list-style-type: none"> • Shut OFF the main power supply before starting electrical work. Otherwise, it could result in electric shocks, break-down or malfunction.
	<ul style="list-style-type: none"> • Do not modify the unit. It could cause electric shocks, fire, or break-down.
	<ul style="list-style-type: none"> • Be sure to turn OFF the power circuit breaker before repairing/inspecting the unit. Repairing/inspecting the unit with the power circuit breaker turned ON could cause electric shocks or injury.
	<ul style="list-style-type: none"> • Do not install the unit in appropriate environment or where inflammable gas could generate, flow in, accumulate or leak. If the unit is used at places where air contains dense oil mist, steam, organic solvent vapor, corrosive gas (ammonium, sulfuric compound, acid, etc) or where acidic or alkaline solution, special spray, etc. are used, it could cause electric shocks, break-down, smoke or fire as a result of significant deterioration of its performance or corrosion.
	<ul style="list-style-type: none"> • Do not install the unit where water vapor is generated excessively or condensation occurs. It could cause electric shocks, fire, or break-down.
	<ul style="list-style-type: none"> • Do not use the unit in a place where it gets wet, such as laundry room. It could cause electric shocks, fire, or break-down.
	<ul style="list-style-type: none"> • Do not operate the unit with wet hands. It could cause electric shocks.
	<ul style="list-style-type: none"> • Do not wash the unit with water. It could cause electric shocks, fire, or break-down.
	<ul style="list-style-type: none"> • Use the specified cables for wiring, and connect them securely with care to protect electronic parts from external forces. Improper connections or fixing could cause heat generation, fire, etc.
	<ul style="list-style-type: none"> • Seal the inlet hole for remote control cable with putty. If dew, water, insect, etc. enters through the hole, it could cause electric shocks, fire or break-down. If dew or water enters the unit, it may cause screen display anomalies.

⚠ WARNING

- **When installing the unit at a hospital, telecommunication facility, etc., take measures to suppress electric noises.**



It could cause malfunction or break-down due to hazardous effects on the inverter, private power generator, high frequency medical equipment, radio communication equipment, etc.
The influences transmitted from the remote control to medical or communication equipment could disrupt medical activities, video broadcasting or cause noise interference.



- **Do not leave the remote control with its upper case removed.**

If dew, water, insect, etc. enters through the hole, it could cause electric shocks, fire or break-down.

⚠ CAUTION

- **Do not install the remote control at following places.**



- (1) It could cause break-down or deformation of remote control.
 - Where it is exposed to direct sunlight
 - Where the ambient temperature becomes 0 °C or below, or 40 °C or above
 - Where the surface is not flat
 - Where the strength of installation area is insufficient
- (2) Moisture may be attached to internal parts of the remote controller, resulting in a display failure.
 - Place with high humidity where condensation occurs on the remote controller
 - Where the remote controller gets wet
- (3) Accurate room temperature may not be detected using the temperature sensor of the remote controller.
 - Where the average room temperature cannot be detected
 - Place near the equipment to generate heat
 - Place affected by outside air in opening/closing the door
 - Place exposed to direct sunlight or wind from air conditioner
 - Where the difference between wall and room temperature is large



- **To connect to a personal computer via USB, use the dedicated software. Do not connect other USB devices and the remote controller at the same time.**
It could cause malfunction or break-down of the remote controller/personal computer.

2 . Accessories & Prepare on site

Following parts are provided.

Accessories	R/C main unit, wood screw (ø3.5 x 16) 2 pcs, Quick reference
-------------	--

Following parts are arranged at site. Prepare them according to the respective installation procedures.

Item name	Q'ty	Remark
Switch box For 1 piece or 2 pieces (JIS C8340 or equivalent)	1	These are not required when installing directly on a wall.
Thin wall steel pipe for electric appliance directly on a wall. (JIS C8305 or equivalent)	As required	
Lock nut, bushing (JIS C8330 or equivalent)	As required	
Lacing (JIS C8425 or equivalent)	As required	Necessary to run R/C cable on the wall.
Putty	Suitably	For sealing gaps
Molly anchor	As required	
R/C cable (0.3 mm ² x 2 pcs)	As required	See right table when longer than 100 m

When the cable length is longer than 100 m, the max size for wires used in the R/C case is 0.5 mm². Connect them to wires of larger size near the outside of R/C. When wires are connected, take measures to prevent water, etc. from entering inside.

≦ 200 m	0.5 mm ² x 2-core
≦ 300m	0.75 mm ² x 2-core
≦ 400m	1.25 mm ² x 2-core
≦ 600m	2.0 mm ² x 2-core

3. Installation place

Secure the installation space shown in the figure.
 For the installation method, "embedding wiring" or "exposing wiring" can be selected.
 For the wiring direction, "Backward", "Upper center" or "Upper left" can be selected.
 Determine the installation place in consideration of the installation method and wiring direction.

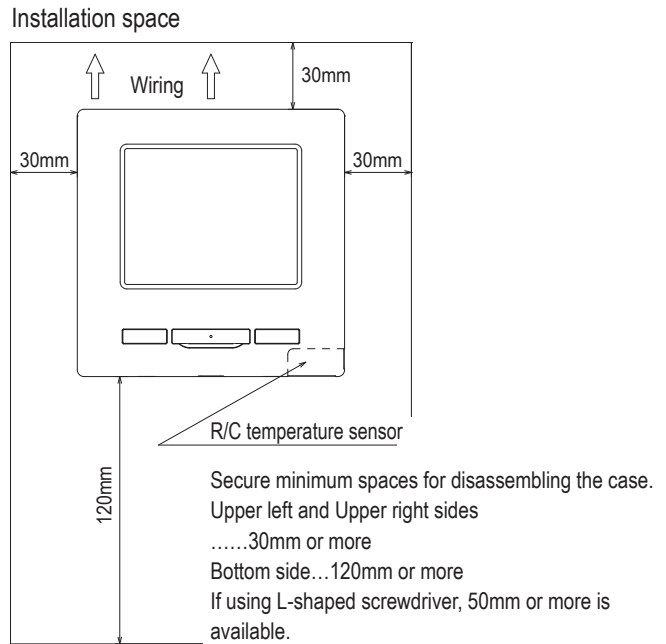

4. Installation procedure

Perform installation and wiring work for the remote controller according to the following procedure.

Dimensions (Viewed from front)

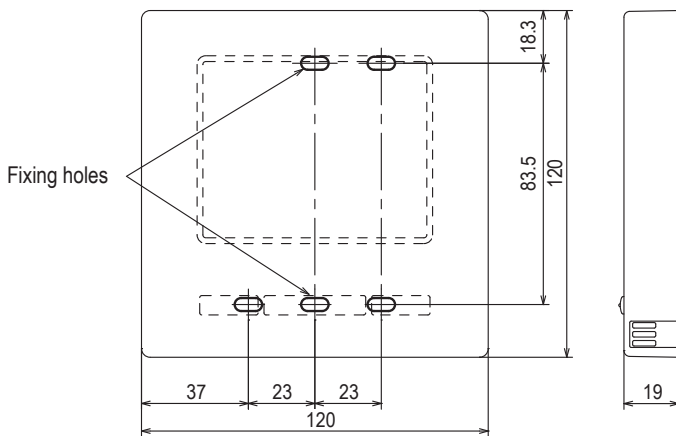

PCB side (Viewed from rear)

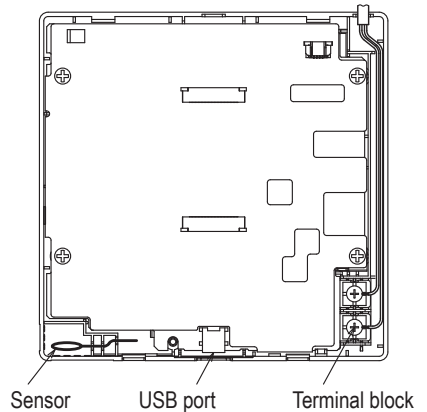

To disassemble the R/C case into the upper and lower pieces after assembling them once

- Insert the tip of flat head screwdriver or the like in the recess at the lower part of R/C and twist it lightly to remove. It is recommended that the tip of the screwdriver be wrapped with tape to avoid damaging the case.

Take care to protect the removed upper case from moisture or dust.

In case of embedding wiring

(When the wiring is retrieved "Backward")

- ① Embed the switch box and the R/C wires beforehand.
 Seal the inlet hole for the R/C wiring with putty.

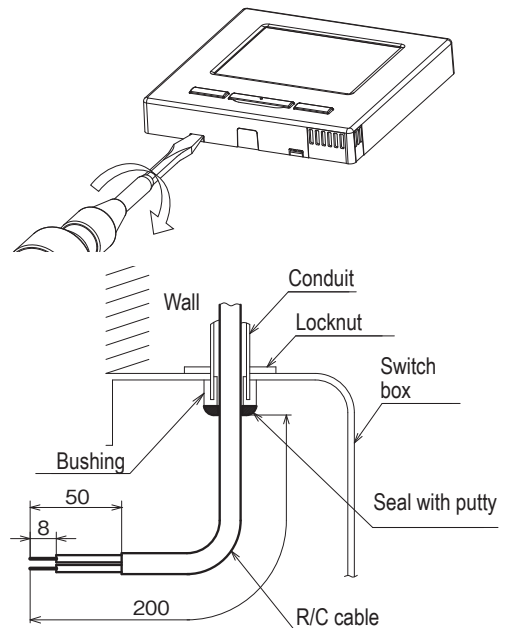

- ② When wires are passed through the bottom case, fix the bottom case at 2 places on the switch box.

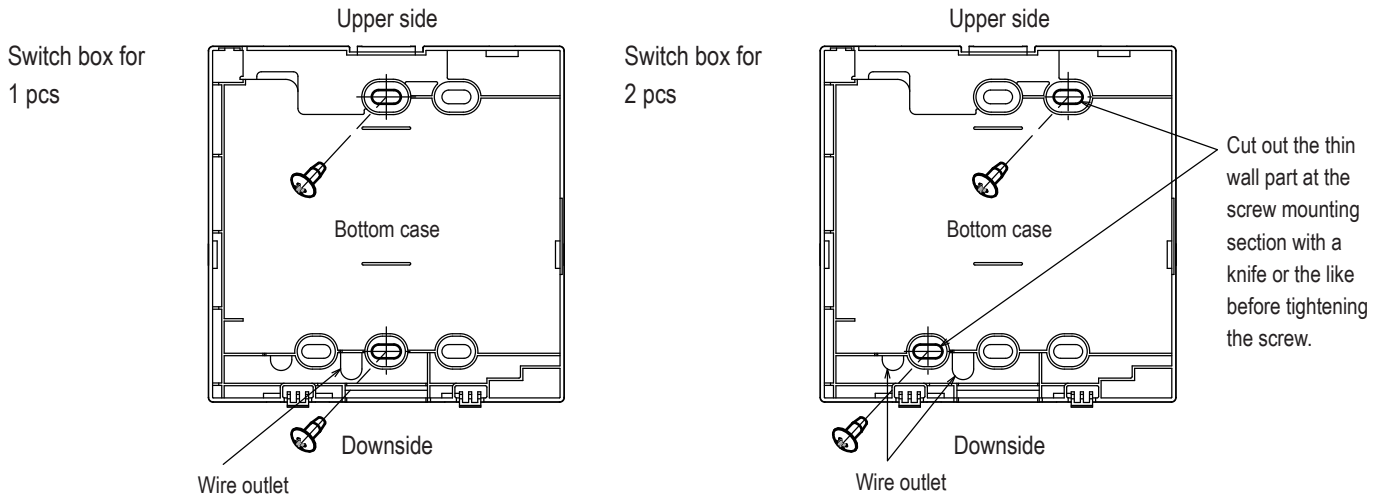

- ③ Connect wires from X and Y terminals of R/C to X and Y terminals of indoor unit. R/C wires (X, Y) have no polarity. Fix wires such that the wires will run around the terminal screws on the top case of R/C.

- ④ Install the upper case with care not to pinch wires of R/C.

Cautions for wire connection

Use wires of no larger than 0.5 mm² for wiring running through the remote control case. Take care not to pinch the sheath.

Tighten by hand (0.7 N·m or less) the wire connection.

If the wire is connected using an electric driver, it may cause failure or deformation.

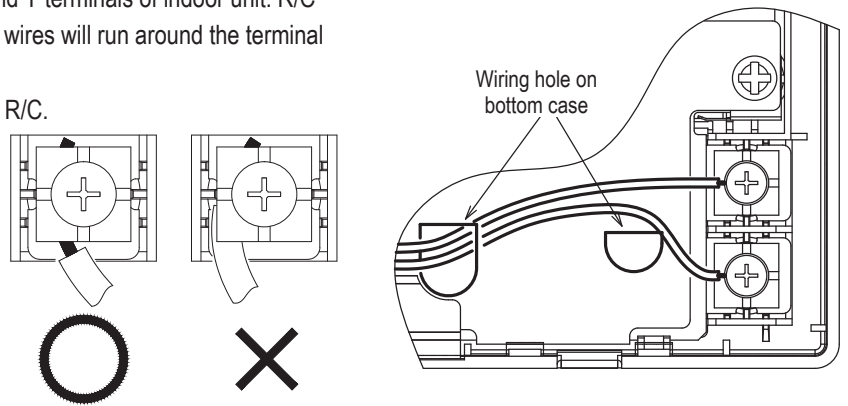

In case of exposing wiring

(When the wiring is taken out from the “upper center” or “upper left” of R/C)

- ① Cut out the thin wall sections on the cases for the size of wire.

When taking the wiring out from the upper center, open a hole before separating the upper and bottom cases. This will reduce risk of damaging the PCB and facilitate subsequent work.

When taking the wiring out from the upper left, take care not to damage the PCB and not to leave any chips of cut thin wall inside.

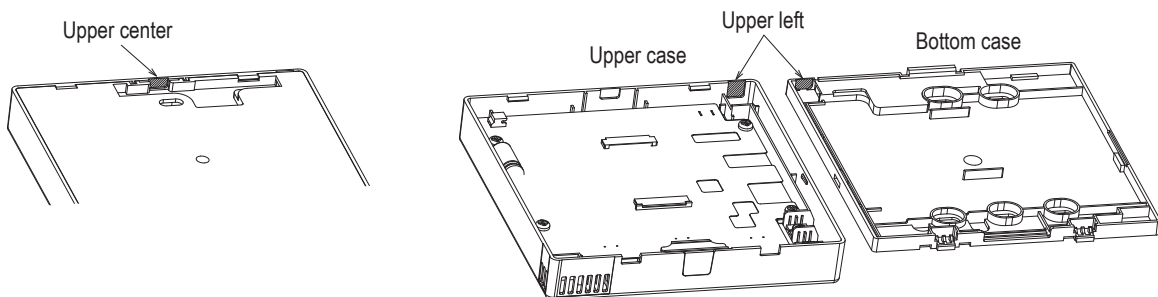

- ② Fix the bottom R/C case on a flat surface with two wood screws.

- ③ In case of the upper center, pass the wiring behind the bottom case. (Hatched section)

- ④ Connect wires from X and Y terminals of R/C to X and Y terminals of indoor unit. R/C wires (X, Y) have no polarity. Fix wires such that the wires will run around the terminal screws on the top case of R/C.

- ⑤ Install the top case with care not to pinch wires of R/C.

- ⑥ Seal the area cut in ① with putty.

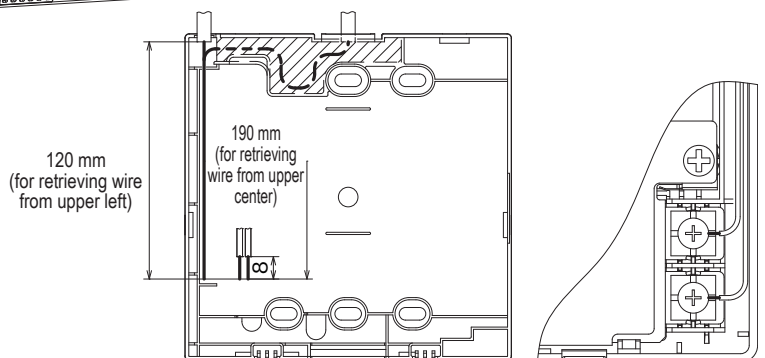

5. Main/Sub setting when more than one remote controls are used

Up to two units of R/C can be used at the maximum for 1 indoor unit or 1 group.

One is main R/C and the other is sub R/C.

Operating range is different depending on the main or sub R/C.

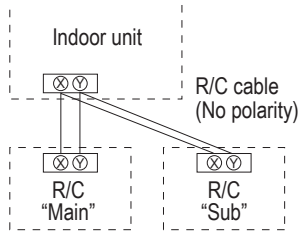

Set the "Main" and "Sub" as described at Section 8.

R/C operations		Main	Sub	
Run/Stop, Change set temp, Change flap direction, Auto swing, Change fan speed operations		○	○	
High power operation, Energy-saving operation		○	○	
Silent mode control		○	×	
Useful functions	Individual flap control	○	×	
	Anti draft setting	○	×	
	Timer	○	○	
	Favorite setting	○	○	
	Weekly timer	○	×	
	Home leave mode	○	×	
	External ventilation	○	○	
	Select the language	○	○	
Silent mode control		○	×	
Energy-saving setting		○	×	
Filter	Filter sign reset	○	○	
User setting	Initial settings		○	○
	Administrator settings	Permission/Prohibition setting	○	×
		Outdoor unit silent mode timer	○	×
		Setting temp range	○	×
		Temp increment setting	○	×
		Set temp display	○	○
		R/C display setting	○	○
		Change administrator password	○	○
		F1/F2 function setting	○	○

○ : operable × : not operable

R/C operations		Main	Sub	
Service setting	Installation settings	Installation date	○	×
		Company information	○	○
		Test run	○	×
		Duct unit settings	○	×
		Change auto-address	○	×
		Address setting of main IU	○	×
	R/C function settings	Main/Sub of R/C	○	○
		Return air temp	○	×
		R/C sensor	○	×
		R/C sensor adjustment	○	×
		Operation mode	○	×
		°C / °F	○	×
		Fan speed	○	×
		External input	○	×
		Upper/lower flap control	○	×
		Left/right flap control	○	×
		Ventilation setting	○	×
		Auto-restart	○	×
Auto temp setting	○	×		
Auto fan speed	○	×		
IU settings		○	×	
Service & Maintenance	IU address		○	○
	Next service date		○	×
	Operation data		○	×
	Error display	Error history	○	○
		Display/erase anomaly data	○	×
		Reset periodical check	○	○
	Saving IU settings		○	×
	Special settings	Erase IU address	○	×
		CPU reset	○	○
		Restore of default setting	○	×
Touch panel calibration		○	○	
Indoor unit capacity display		○	×	

Advice: Connection to personal computer

- It can be set from a personal computer via the USB port (mini-B).
- Connect after removing the cover for USB port of upper case.
- Replace the cover after use.
- Special software is necessary for the connection.
- For details, view the web site or refer to the engineering data.

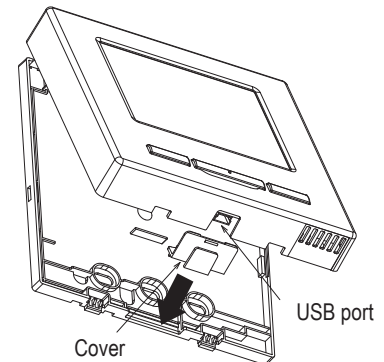

Advice: Initializing of password

- Administrator password (for daily setting items) and service password (for installation, test run and maintenance) are used.
- The administrator password at factory default is "0000". This setting can be changed (Refer to User's Manual).
- If the administrator password is forgotten, it can be initialized by holding down the [F1] and [F2] switches together for five seconds on the administrator password input screen.
- Service password is "9999", which cannot be changed.
- When the administrator password is input, the service password is also accepted.

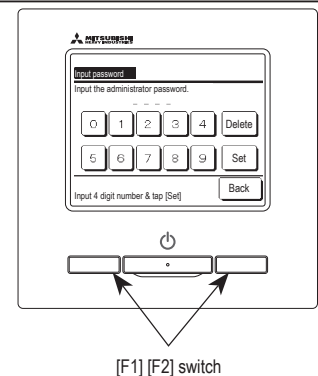

Advice

When connecting two or more FDT/FDTC to one R/C, unify the panel type either to a panel with anti draft function or a standard panel.

6. Functions and menu items of the remote control

Names and functions of sections on the R/C (Operating section)

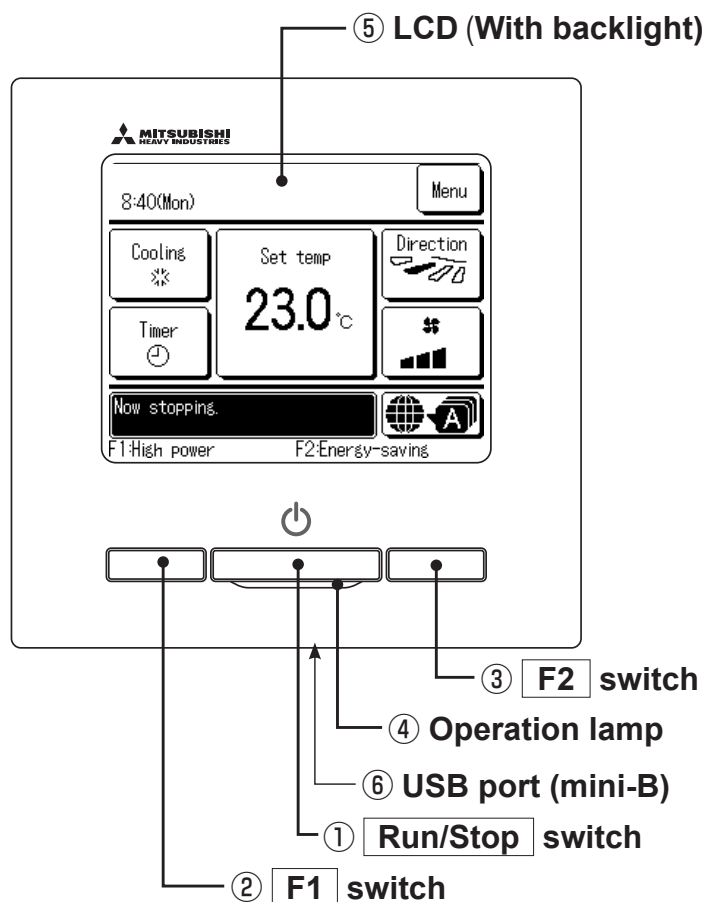

Touch panel system, which is operated by tapping the LCD screen with a finger, is employed for any operations other than the ① Run/Stop, ② F1 ③ F2 switches.

① Run/Stop switch

One push on the button starts operation and another push stops operation.

② F1 switch ③ F2 switch

This switch starts operation that is set in F1/F2 function setting.

④ Operation lamp

This lamp lights in green (yellow-green) during operation. It changes to red (orange) if any error occurs.

Operation lamp luminance can be changed.

⑤ LCD (With backlight)

A tap on the LCD lights the backlight.

The backlight turns off automatically if there is no operation for certain period of time.

Lighting period of the backlight lighting can be changed.

If the backlight is ON setting, when the screen is

tapped while the backlight is turned off, the backlight only is turned on. (Operations with switches ①, ② and ③ are excluded.)

⑥ USB port

USB connector (mini-B) allows connecting to a personal computer.

For operating methods, refer to the instruction manual attached to the software for personal computer (remote control utility software).

Note

When connecting to a personal computer, do not connect simultaneously with other USB devices.

Please be sure to connect to the computer directly, without going through a hub, etc.

Names and functions of sections on the R/C (Display)

*All icons are shown for the sake of explanation.

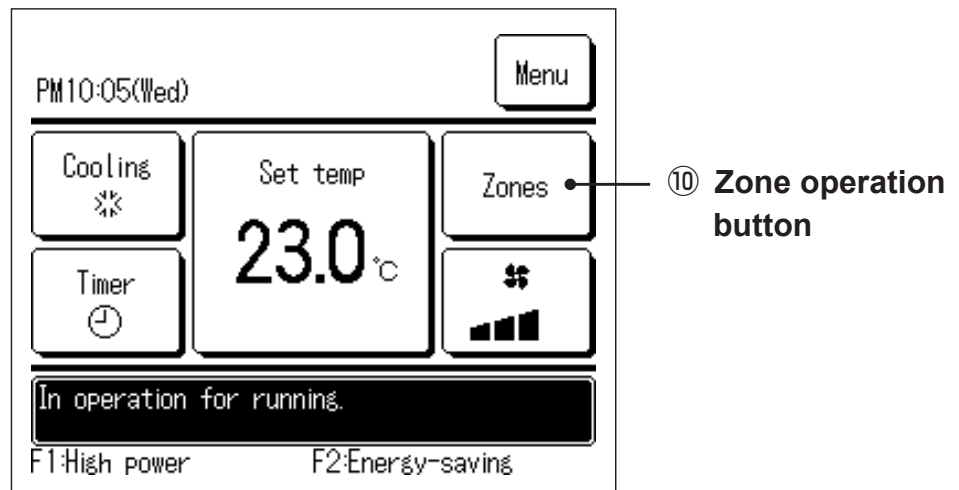
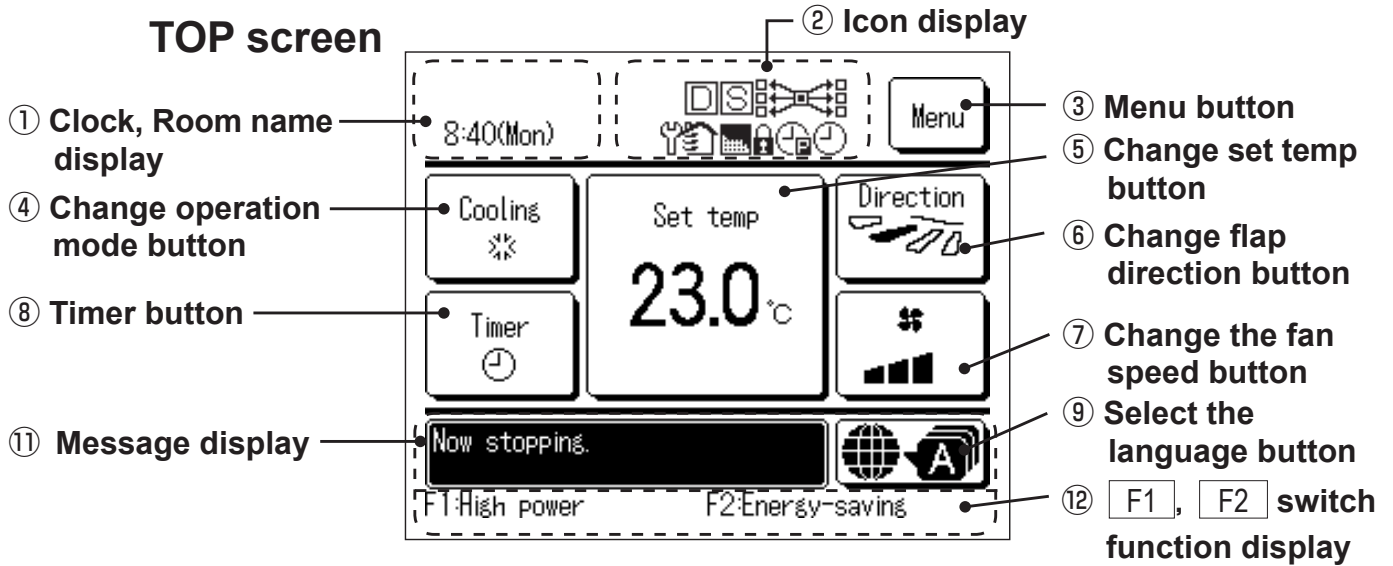



① Clock, Room name display

Displays the current time and the room name.

② Icon display

Each icon is displayed when one of following settings is going on.

 When the demand control is effective.

 When setting is made from the sub R/C.

 When the central control (Optional) is running.

 When the periodical inspection is necessary.

 During the ventilation operation.

 When "filter sign" is up.

 When the Permission/Prohibition setting is made.

 When the peak-cut timer is set.

 When the weekly timer is set.

③ Menu button

When setting or changing other than the following ④-⑧, tap the menu button. Then menu items are displayed, select one and set.

④ Change operation mode button

Displays the operation mode which is selected currently. Tap this button to change the operation mode.

⑤ Change set temp button

Displays the temperature which is set currently. Tap this button to change the set temperature.

⑥ Change flap direction button

Displays the flap direction which is selected currently. When the 3D auto flow operation is enabled, 3D auto display will appear. Tap this button to change the flap direction.

⑦ Change the fan speed button

Displays the fan speed which is selected currently. Tap this button to change the fan speed.

⑧ Timer button

Displays simplified contents of the timer which is set currently.
(When two or more timers are set, contents of the timer which will be operated immediately after is displayed.)
Tap this button to set the timer.

⑨ Select the language button

Select a language to be displayed on the R/C.



⑩ Zone operation button

Tap this button to go to the zone operation screen.

⑪ Message display

Status of air conditioner operation and messages of the R/C operations etc. are displayed.

⑫ F1, F2 switch function Display

Displays the function that is set for each ,  switch.
The function for these switches can be changed in F1/F2 function setting.

7. Main item

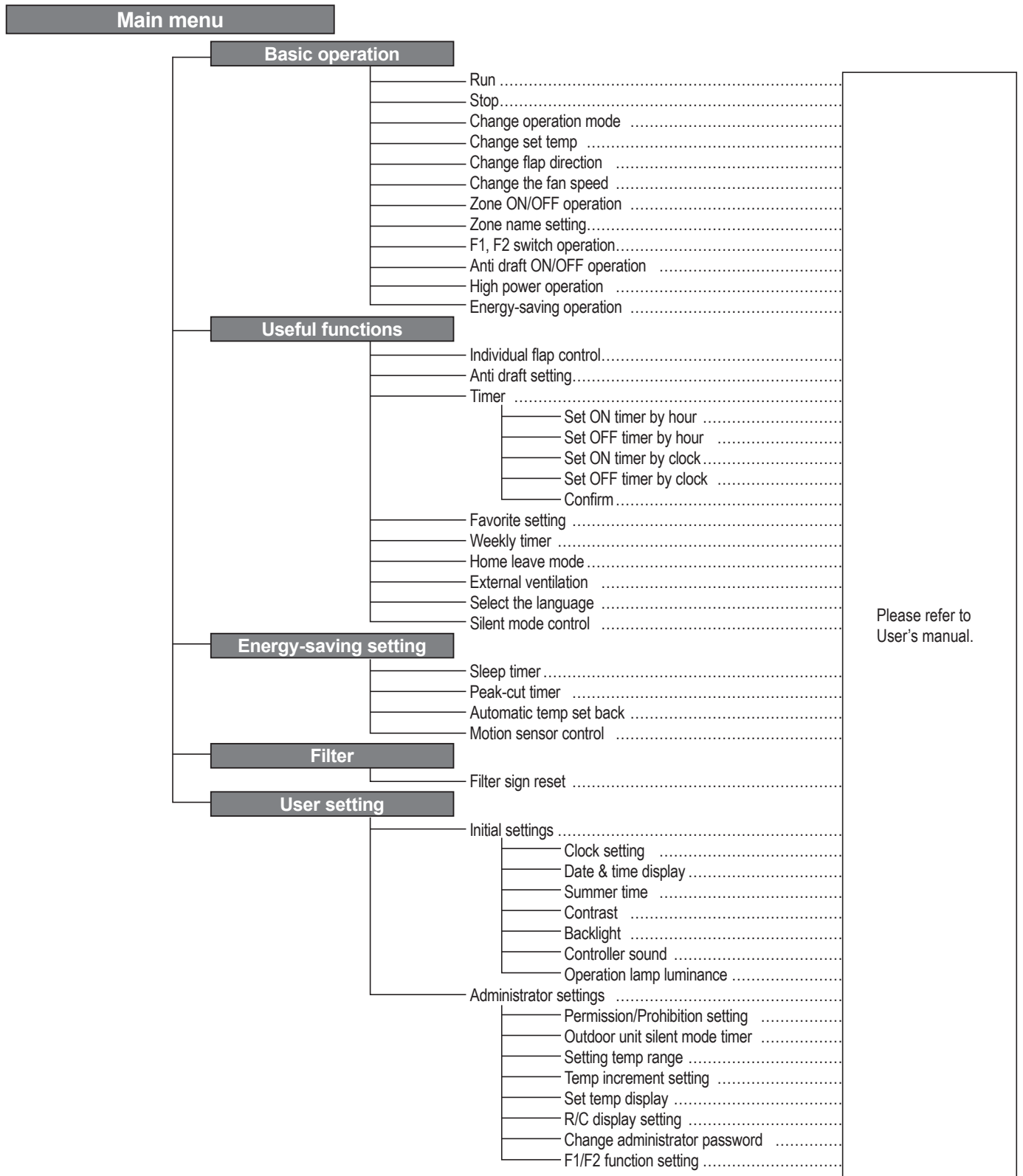

Main menu

Service setting

- Installation settings
 - Installation date 16
 - Company information 16
 - Test run 16
 - Duct unit settings 17
 - Change auto-address 18
 - Address setting of main IU 18
 - IU back-up function 18
 - Motion sensor setting 19
- R/C function settings
 - Main/Sub of R/C 20
 - Return air temp 20
 - R/C sensor 20
 - R/C sensor adjustment 21
 - Operation mode 21
 - °C / °F 21
 - Fan speed 21
 - External input 21
 - Upper/lower flap control 22
 - Left/right flap control 22
 - Ventilation setting 22
 - Auto-restart 22
 - Auto temp setting 22
 - Auto fan speed 22
- IU settings
 - Fan speed setting 23
 - Filter sign 24
 - External input 1 24
 - External input 1 signal 24
 - External input 2 24
 - External input 2 signal 24
 - Heating thermo-OFF temp adjustment 25
 - Return temperature adjustment 25
 - Fan control in cooling thermo-OFF 25
 - Fan control in heating thermo-OFF 25
 - Anti-frost temp 25
 - Anti-frost control 25
 - Drain pump operation 26
 - Keep fan operating after cooling is stopped 26
 - Keep fan operating after heating is stopped 26
 - Intermittent fan operation in heating 26
 - Fan circulator operation 26
 - Control pressure adjust 26
 - Auto operation mode 27
 - Thermo. rule setting 29
 - Auto fan speed control 29
 - IU overload alarm 30
 - External output setting 30
- Service & Maintenance
 - IU address 31
 - Next service date 31
 - Operation data 31
 - Error display 32
 - Saving IU settings 33
 - Special settings 34
 - Indoor unit capacity display 34

Contact company

Contact company

Please refer to
User's manual.

8. Power on and initial setting

Set the main and sub R/C units according to the display at the power on.

- Main/Sub setting not performed => (1)
- Main/Sub setting performed => (2)

(1) When the main and sub are not yet set,

①⇒② Main/sub input screen is displayed.

When tapping the or button, initial setting starts.

If any wrong button has been tapped by mistake, the setting can be changed after the end of the initializing operation. (10. R/C function setting④)

When using two remote controllers for one IU or one group, if the first one is set for the , the second is set for the automatically.

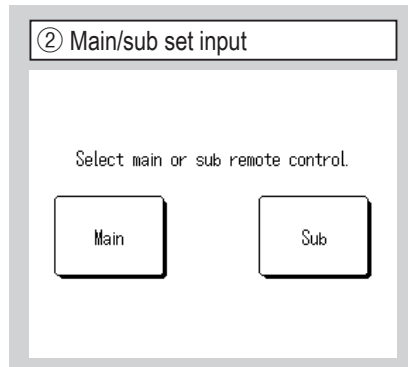
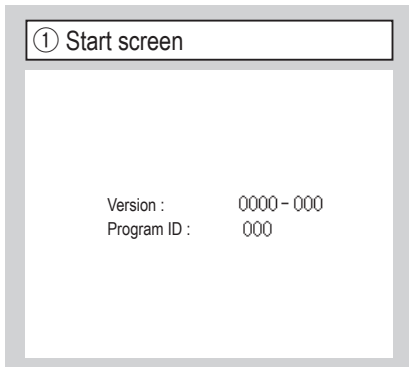

Caution

When only one unit of R/C is used, tap the button. In the state of initial setting, if either one of buttons ([Main]/[Sub]) is not tapped, it keeps the screen unchanged.

The screen changes to ③⇒④⇒⑤.

The screen changes to ①⇒⑧⇒⑤.

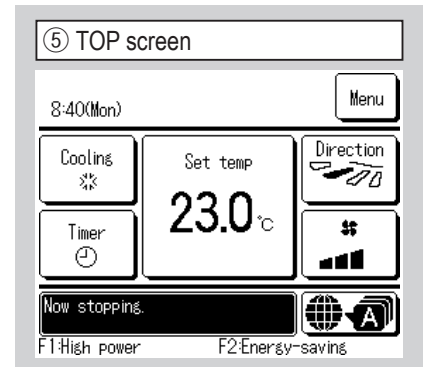
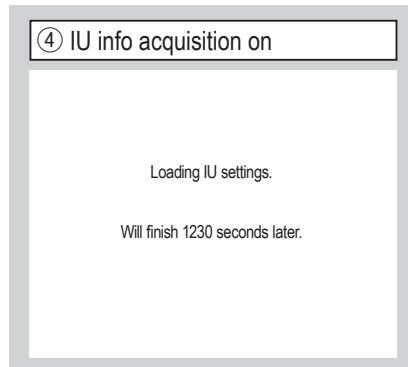
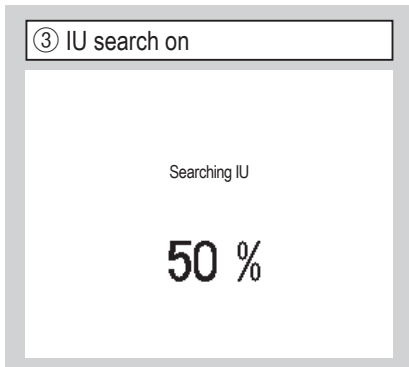

The red LED will blink if communication is not established in ten minutes.

(2) **When the main and sub are set**

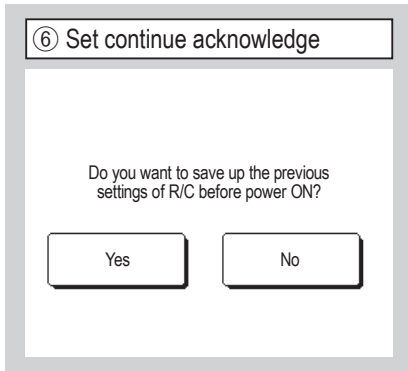

The screen changes to ⑧⇒⑤.

The screen changes to ⑦.

If the screen is not tapped for more than 15 seconds, the (Continue) is selected and the display changes to the screen of ⑤.

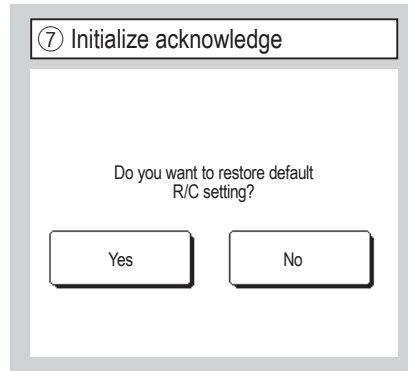

The screen changes to ①⇒②.

The screen changes to ⑥.

After the initializing, it returns to the default state.

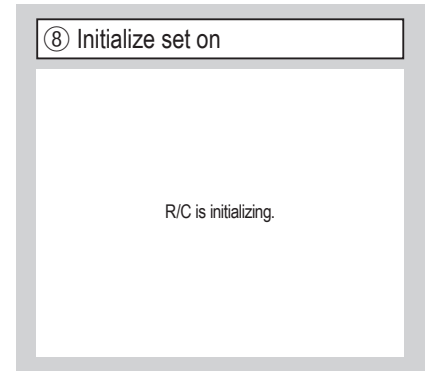

9. Installation settings and test run

TOP screen ⇒ ⇒ ⇒

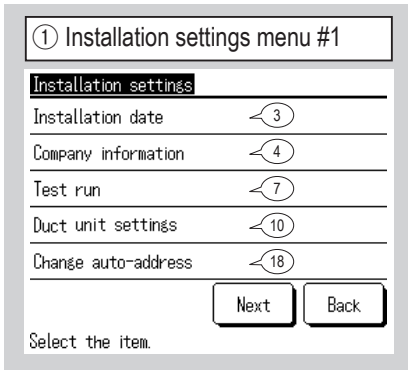

The selected screen is displayed.

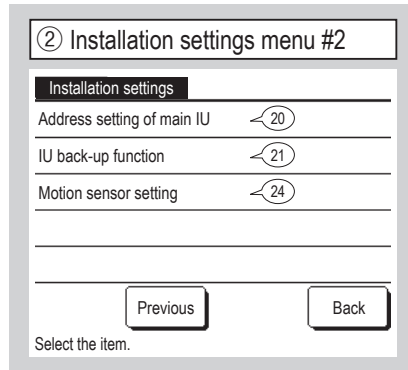

The selected screen is displayed.

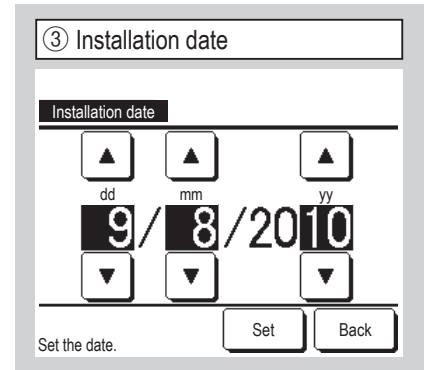

Select the date with buttons, and tap the button.

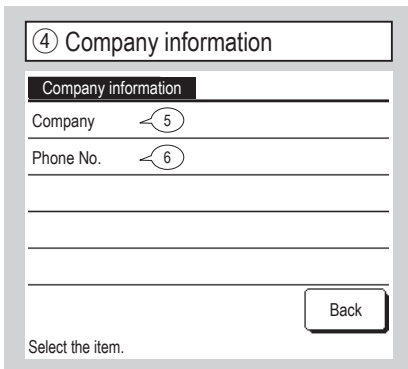

Enter the company information.

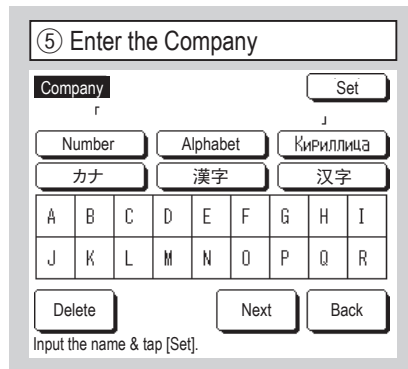

Enter the company name using up to 26 one-byte characters and then tap the button. You can enter alphanumeric, Japanese Kana, Kanji, Cyrillic, or Chinese characters.

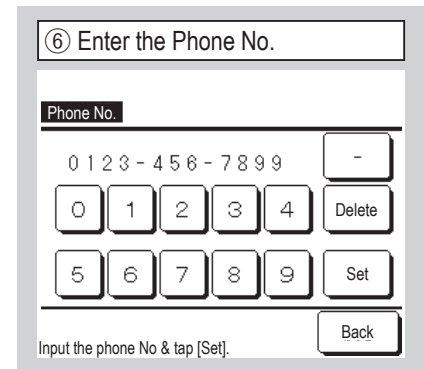

Enter the phone number of the company using up to 13 characters and then tap the button.

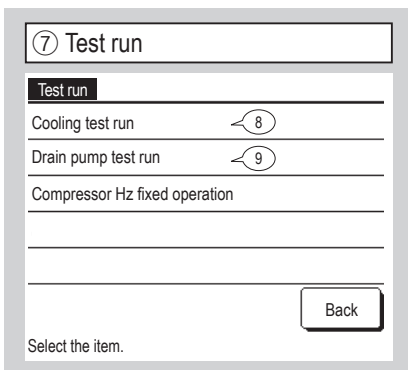

The selected screen is displayed.

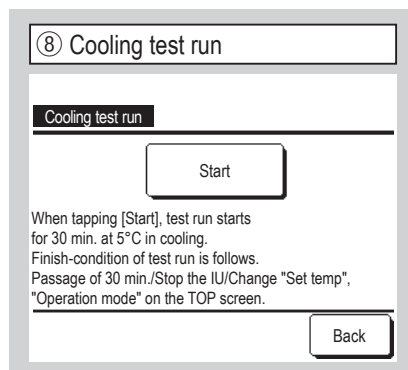

This can be operated while cooling is stopped. When the room temperature is too low to start the cooling test run, it operates for 30 minutes by decreasing the set temperature to 5°C.

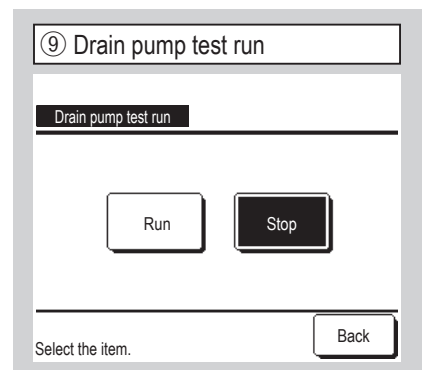

Drain pump can be operated independently.

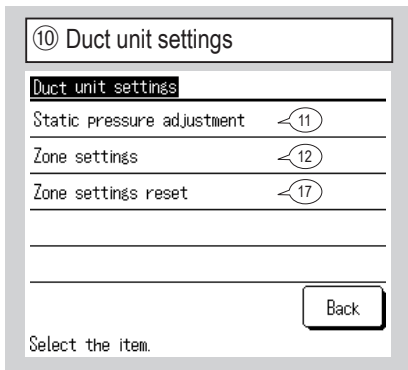

Static pressure adjustment :
Performs external static pressure Adjustment for the duct unit.

Zone settings : Set when performing zone control.

Zone settings reset : Resets all zone settings.

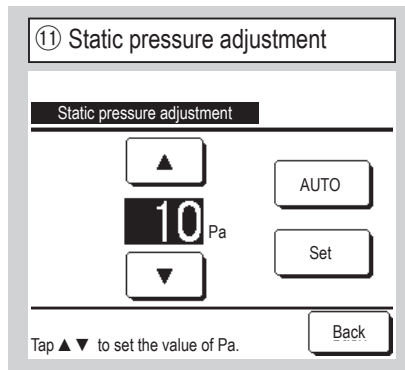

This is operable in case of connecting duct type IU equipped with the external static pressure adjustment function. Select the external static pressure and tap the **Set** button.

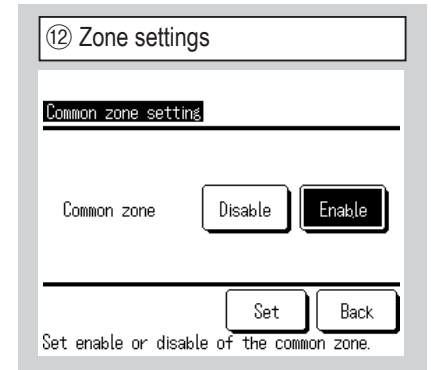

Set when performing zone control.
Set whether or not there is a common zone.
(Enable: Present, Disable: Not present)
A common zone is a zone in which a damper is not installed.

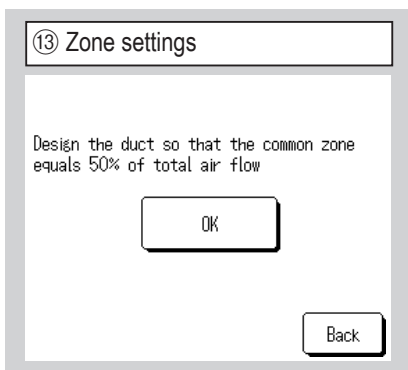

Design the duct so that the common zone equals 50% of total air flow.
If this is acceptable, tap the **OK** button.

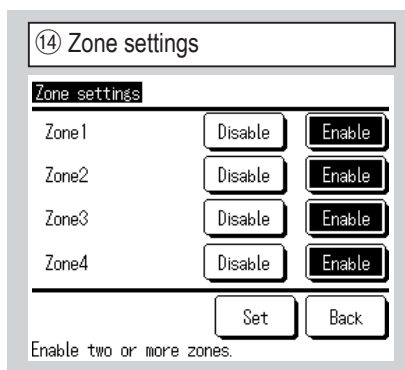

Set the existence of zones 1 to 4. (Enable: Present, Disable: Not present)
Zones 1 to 3 can be set when setting common zones.

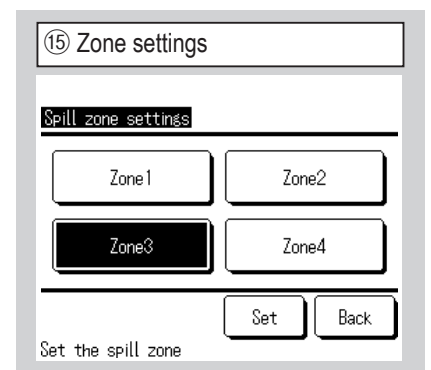

Select a Spill zone.
Zones set as spill zones will automatically open if the spill zone is closed and one or more other zone are closed.
Spill zone selection is required when there is no common zone. This screen will not be displayed if there is a common zone.

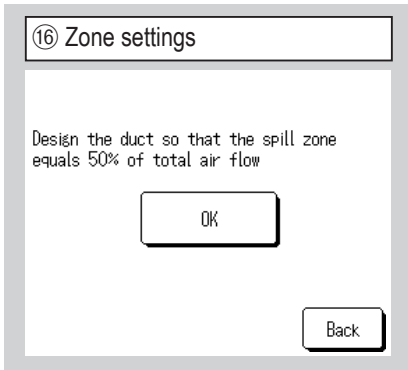

Design the duct so that the spill zone equals 50% of total air flow.
If this is acceptable, tap the **OK** button.

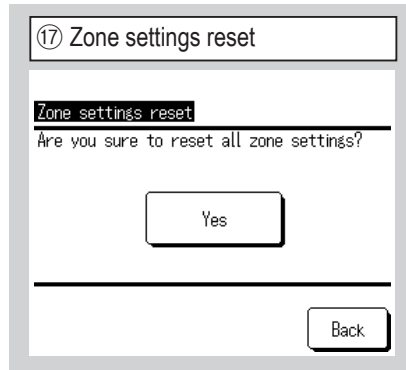

Resets all zone settings.
If this is acceptable, tap the **Yes** button.

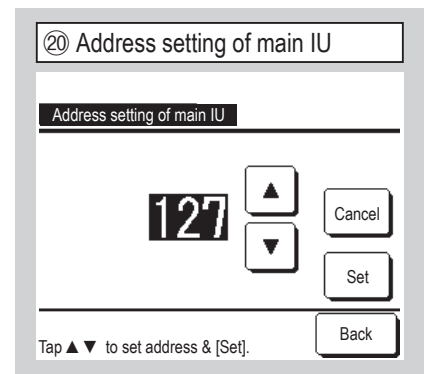
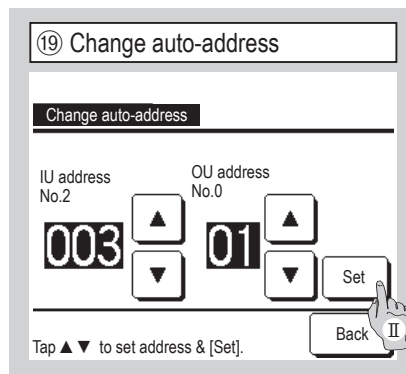
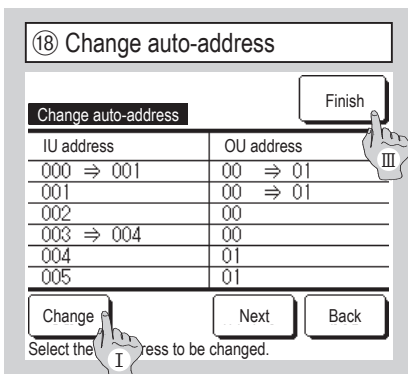

In case of Multi series (KX) models, the IU addresses registered with the auto-address setting method can be changed with this function.

This function changes the OU address for each IU. Select an IU and,

- I When an indoor unit is selected and the **Change** button is tapped, the display changes to the Change auto-address screen (19).
- II Tap the **Set** button to return to the screen (18) and display the new address.
- III Tap the **Finish** button to register the new address.

In case of Multi Series (KX) models, it is possible to let indoor units (Sub IUs) follow the operation mode (Heating, cooling) of the indoor unit (Main IU). Set the address of the Main IU to the Sub IUs. The Sub IUs to which the Main IU address is set follow the Main IU settings.

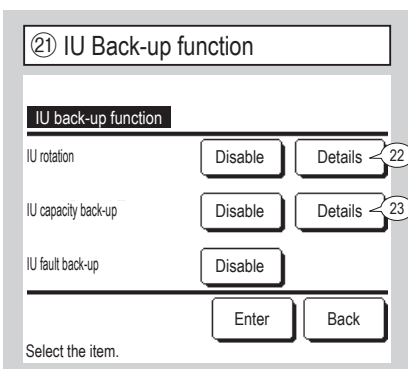

In case of 2 sets of indoor units (2 groups) connected to one R/C, it is available to perform back-up operation with them.

1. IU rotation: Operate 2 sets of indoor units alternately at every set time of operation interval.
 2. IU capacity back-up: When the temp difference between the set temp and the actual room temp is higher than the set temp diff., 2 sets of indoor units operate.
 3. IU fault back-up: If one of the IU has a fault and stops, the other one starts operation.
- Select **Enable** / **Disable** (tapping **Disable** changes to **Enable**) and tap the **Enter** button to confirm the settings.

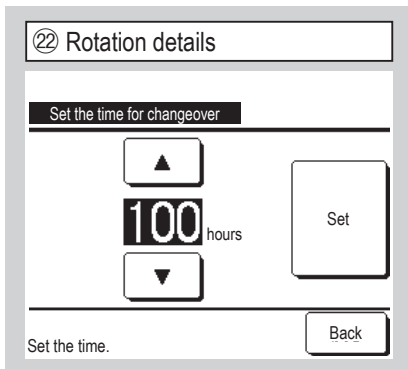

In IU rotation function, the timer to changeover the operation of 2 indoor units is set.

The timer can be set within the range of 1 to 999 hours in increments of one hour.

After the time is changed, tap for temporary setting.

After temporary setting, return to the IU Back-up function screen and tap .

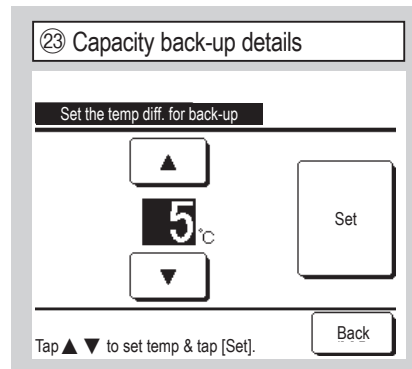

The difference between the setting temperature for a change between one unit and two units for capacity back-up and room temperature is set.

The temperature can be set within the range of 2 to 5 °C in increments of 1 °C.

After the temperature is changed, tap for temporary setting.

After temporary setting, return to the IU Back-up function screen and tap .

Back-up control restrictions

1. The back-up control is unavailable when the operation mode is "Auto". When the back-up control is set for the air conditioner that specifies "Auto" for the operation mode, the operation mode changes to "Cooling" automatically.
2. When the rotation control is set, the fault back-up control will be enabled automatically. In this case, the fault back-up control cannot be disabled alone. When the rotation operation is disabled, the fault back-up control will also be disabled.
3. When the capacity back-up control is set, the fault back-up control will be enabled automatically. In this case, the fault back-up control cannot be disabled alone. When the capacity back-up control is disabled, the fault back-up control will also be disabled.
4. It is also possible to enable the fault back-up control alone.
5. The home leave mode, warming up and external input cannot be set together with the back-up control.
6. While the rotation or fault back-up control is set, either of the two target indoor units (two groups) will operate. Both units will not operate at the same time.
7. An indoor unit having younger address will start the operation first in each control.

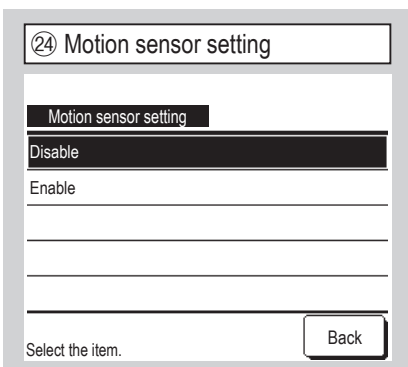

Select Enable Disable for the motion sensor of the indoor unit connected to the R/C.

- For customers who adapt a motion sensor, please proceed the setting shown on the left and enable the indoor unit to be used to detect the activity amounts of persons. When the motion sensor is disabled, activity amounts of persons will not be detected and thus the motion sensor control (power saving and auto-off) will not be performed.
- For indoor units without a motion sensor, tap the Motion sensor setting to display "Invalid request".

10. R/C function settings Advice: It is valid when unit stops.

TOP screen Menu ⇒ Service setting ⇒ R/C function settings ⇒ Service password

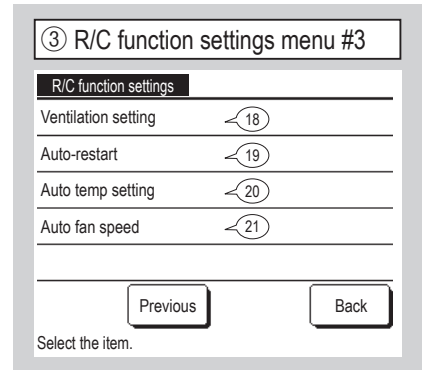
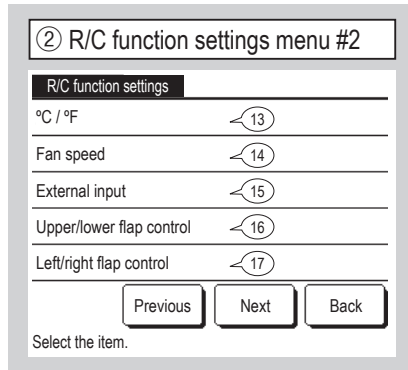
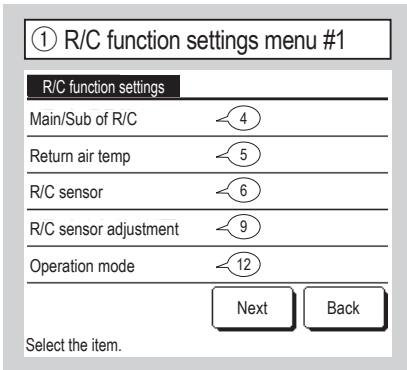

The selected screen is displayed.

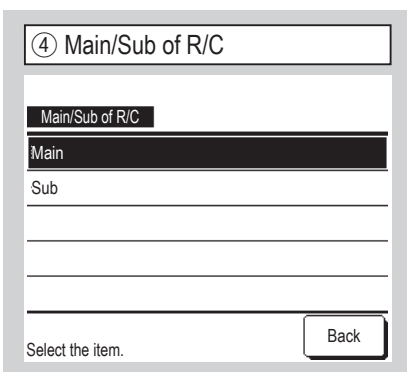

Use this when changing the Main/Sub setting of R/C.

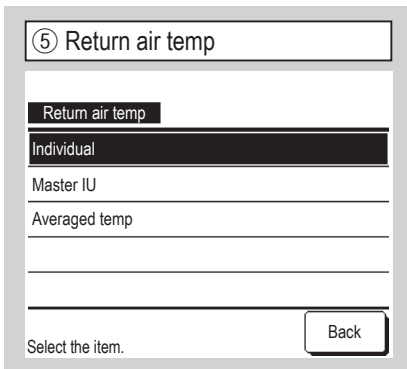

Thermo. rule is applied based on the temperature detected with the return air temp sensor of IU.

When plural indoor units are connected to one R/C, the return air temp applied to the thermo. rule can be selected.

1. Individual : Thermo. rule is applied based on the return air temp of each IU. When plural units are connected to one R/C, it is based on the return air temp of the main unit.
2. Master IU : Thermo. rule is applied based on the return air temp of IU having the youngest address out of IUs connected.
If there are several sets of plural units each of which is connected to one R/C, it is based on the IU having the youngest address out of the main units of each plural units.
3. Averaged temp : Thermo. rule is applied based on the average of return air temperatures of IUs connected.

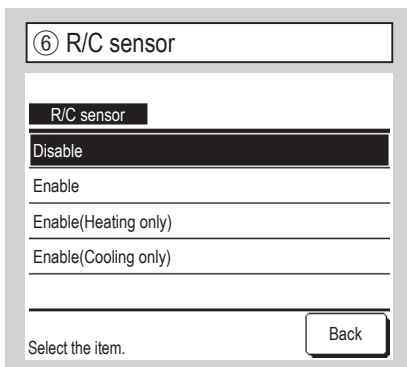

You can change IU main unit return air temperature sensor to the R/C side.

- Disable The Indoor temp display changes to the temperature measured by the sensor at the main unit. ⇒ ⑦
- Enable The Indoor temp display changes to the temperature measured by the R/C side sensor. ⇒ ⑧
- Enable(Heating only) The Indoor temp display changes to the temperature measured by the R/C side sensor during heating only.
- Enable(Cooling only) The Indoor temp display changes to the temperature measured by the R/C side sensor during cooling only.

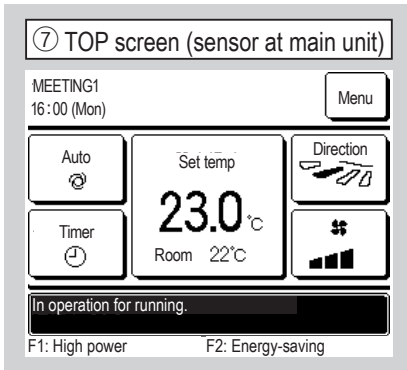

When the R/C sensor is disabled, the TOP screen displays "Room ○ °C".

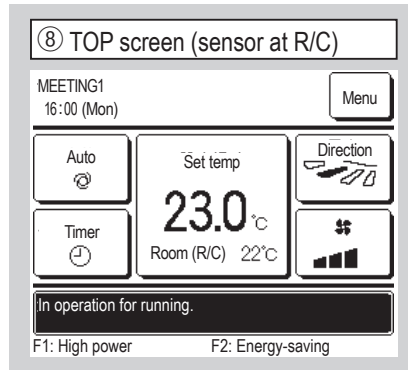

When the R/C sensor is enabled, the TOP screen displays "Room (R/C) ○ °C".

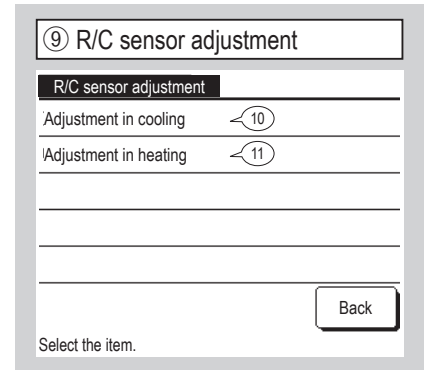

You can adjust the R/C sensor detection temperature.

- ⇒ ⑩
- ⇒ ⑪

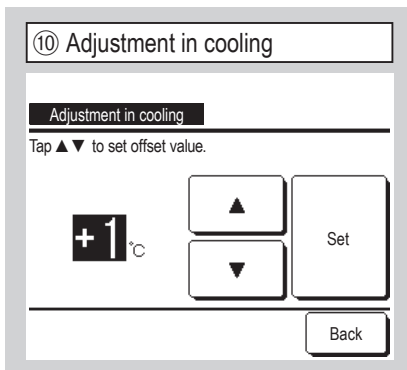

The R/C sensor detection temperature during cooling operation can be corrected. Set the value within the range of -3 to +3.

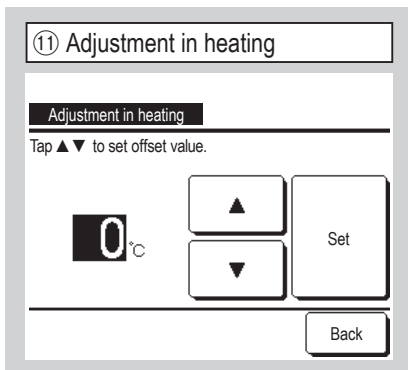

The R/C sensor detection temperature during heating operation can be corrected. Set the value within the range of -3 to +3.

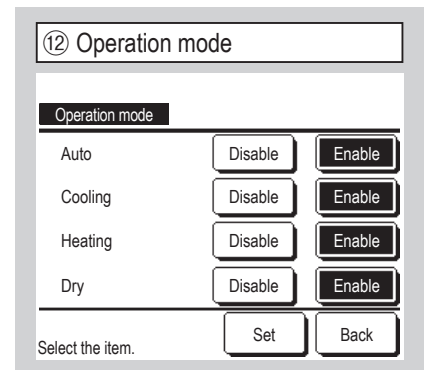

or can be set for each operation mode. If the cooling or heating is disabled, the auto is also disabled.

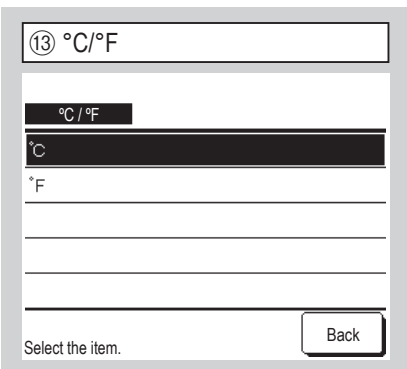

Select the unit of temperature displayed on the R/C.

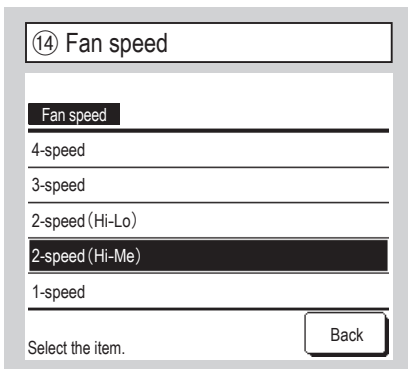

Fan speed can be changed to the selected one. It may not be available to select some of fan speeds depending on indoor unit models.

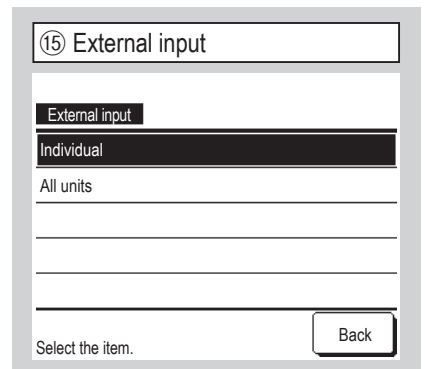

Set the range to apply the external input received through CNT of either one IU to plural indoor units connected in one system

- This is applied only to the IU receiving CNT input.
- This is applied to all indoor units connected.

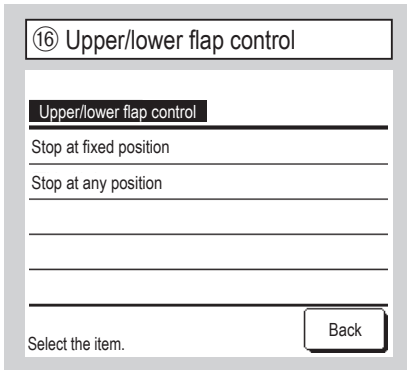

Stop at fixed position The upper/lower flap can be set to stop at one of four positions.

Stop at any position The flap can be set to stop at any position immediately after operating the R/C switch.

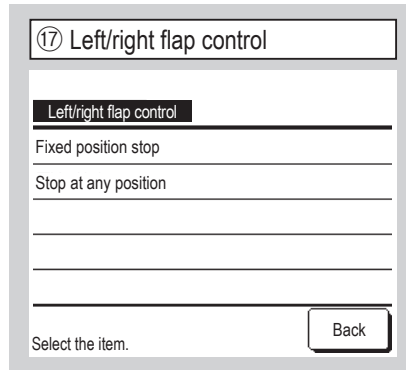

Fixed position stop The left/right flap can be set to stop in eight different patterns.

Stop at any position The flap can be set to stop at any position immediately after operating the R/C switch.

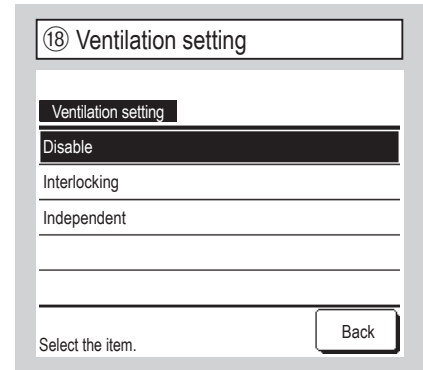

Set this when a ventilation device is connected.

Disable No ventilation device is connected.

Interlocking Ventilation is interlocked with the Run/Stop of air conditioner and operate the Ventilation output.

Independent If the ventilation is selected from the menu, only the ventilation device is operated or stopped independently.

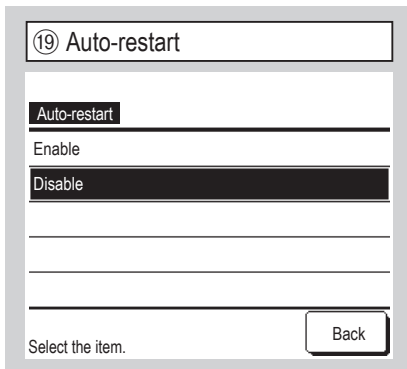

If the unit stops during operation,
 Enable It returns to the state before the power failure as soon as the power supply is restored (After the end of the primary control at the power on).
 Disable It stops after the restoration of power supply.

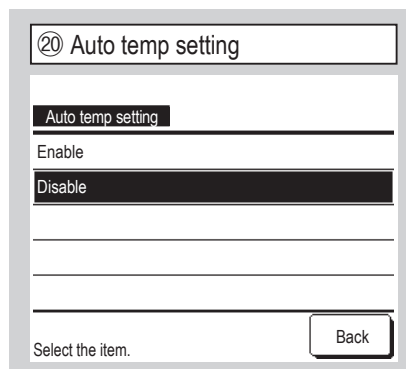

Enable Auto can be selected on the room temperature setting screen.

Disable Auto selection switch will not be displayed on the room temperature setting screen.

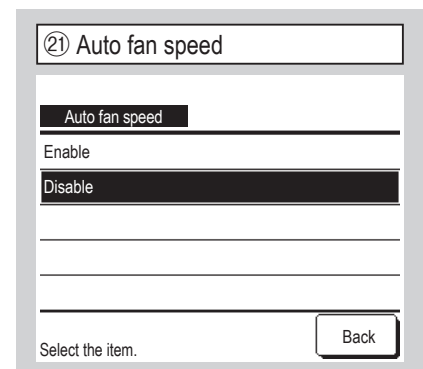

Enable Auto can be selected on the fan speed setting screen.

Disable Auto selection switch will not be displayed on the fan speed setting screen.

11. IU settings Advice: It is valid when unit stops.

TOP screen Menu ⇒ Service setting ⇒ IU settings ⇒ Service password

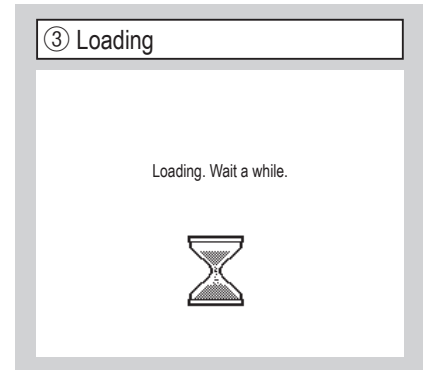
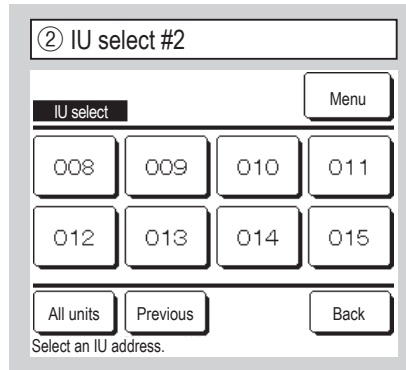
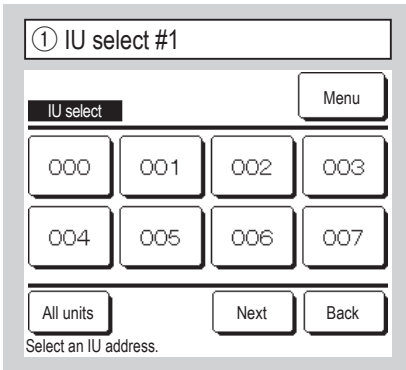

When plural indoor units are connected, they are displayed on the screen.

000 to 015 Individual settings are performed for indoor units.

All units The same setting applies to all units.

The display changes to ④ after receiving data from the IU.

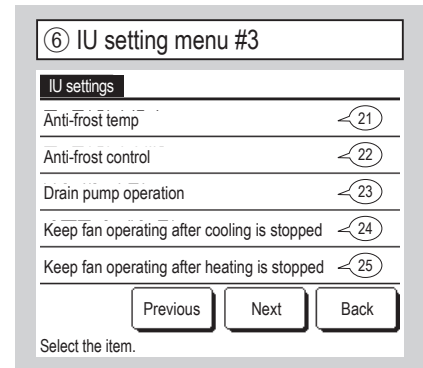
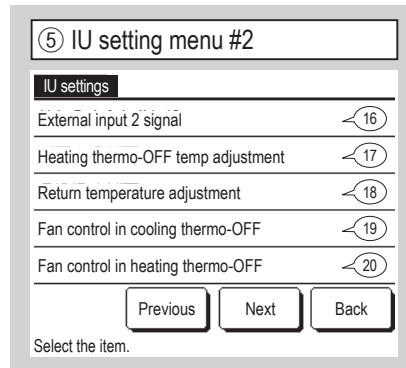
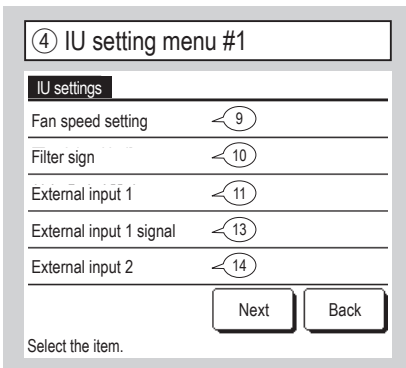

The selected screen is displayed.

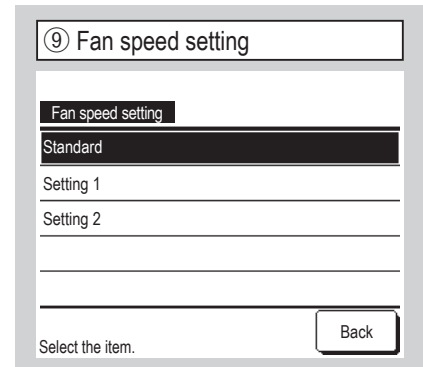
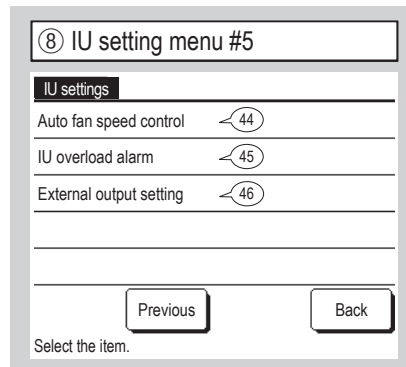
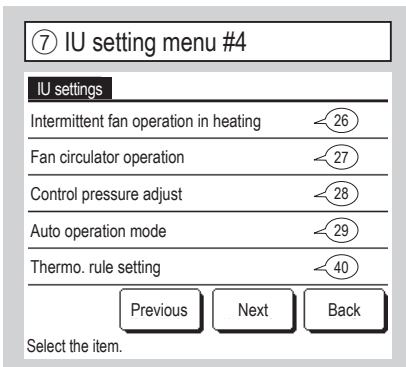

Set the fan speed tap for the IU. Refer to the engineering data for details.

⑩ Filter sign

Filter sign

No display

Setting 1

Setting 2

Setting 3

Setting 4

Select the item. Back

	Standard
No display	None
Setting 1	180Hr
Setting 2	600Hr
Setting 3	1,000Hr
Setting 4	1,000Hr Operation stop

Set the time to display the filter sign.

⑪ External input 1 #1

External input 1

Run/Stop

Permission/Prohibition

Cooling/Heating

Emergency stop

Setting temperature shift

Select the item. Next Back

⑫ External input 1 #2

External input 1

Forced thermo-OFF

Temporary stop

Silent mode

Select the item. Previous Back

⑬ External input 1 signal

External input 1 signal

Level input

Pulse input

Select the item. Back

Set the control at the time when the signal is input to the external input 1 (CNT) of IU.
Refer to the engineering data for details.

Set the signal type to input to the external input 1 (CNT) of IU.
Refer to the engineering data for details.

This is operable when the IU equipped with the external input 2 is connected. Refer to the engineering data for details.

⑭ External input 2 #1

External input 2

Run/Stop

Permission/Prohibition

Cooling/Heating

Emergency stop

Setting temperature shift

Select the item. Next Back

⑮ External input 2 #2

External input 2

Forced thermo-OFF

Temporary stop

Silent mode

Select the item. Previous Back

⑯ External input 2 signal

External input 2 signal

Level input

Pulse input

Select the item. Back

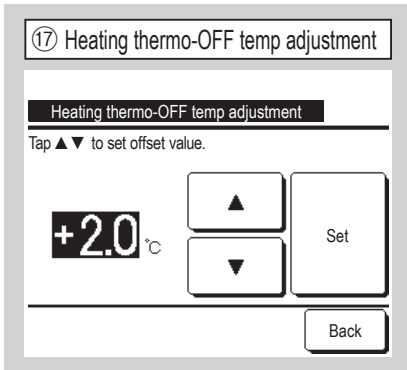

Adjust the temperature for judging to make thermostat ON or OFF during heating operation.

Adjustable range is 0°C / +1°C / +2°C / +3°C.

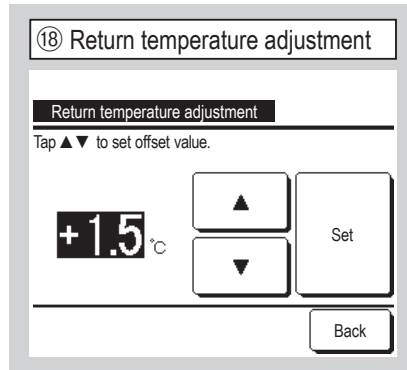

Adjust the main return air temperature sensor detection temperature.

Adjustable range is -2°C / -1.5°C / -1°C / 0°C / +1°C / +1.5°C / +2°C.

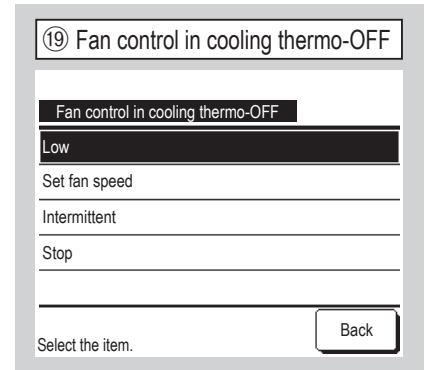

Set the fan speed at the cooling thermo-OFF.

Low The fan runs at the low speed.

Set fan speed The fan runs at the same speed as that during the thermo-ON operation.

Intermittent Cycles of Lo fan operation for 2 minutes and stop for 5 minutes are repeated.

Stop The fan is stopped.

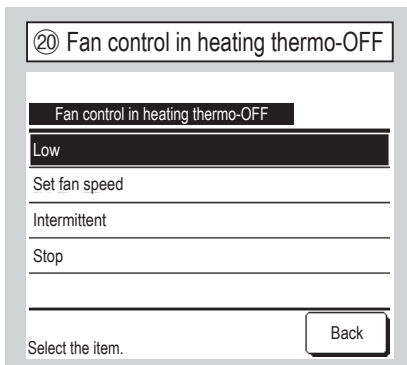

Set the fan speed at the heating thermo-OFF.

Low The fan runs at the low speed.

Set fan speed The fan runs at the same speed as that during the thermo-ON operation.

Intermittent Cycles of Lo fan operation for 2 minutes and stop for 5 minutes are repeated.

Stop The fan is stopped.

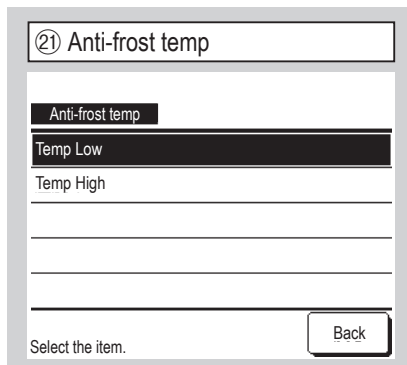

Select the anti-frost control temperature.

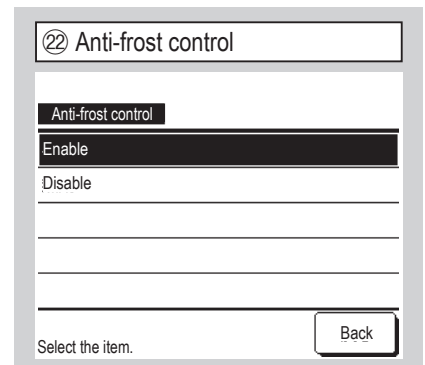

Set the fan control during the anti-frost control.

Enable The fan speed increases during the anti-frost control.

Disable The fan speed does not change during the anti-frost control.

②③ Drain pump operation

Drain pump operation

Standard (in cooling & dry)

Operate in standard & heating

Operate in heating & fan

Operate in standard & fan

Select the item.

Operates in cooling and dry modes.

Operates in cooling, dry and heating modes.

Operates in all modes.

Operates in cooling, dry and fan modes.

②④ Keep fan operating after cooling is stopped

Keep fan operating after cooling is stopped

No setting

Setting 1

Setting 2

Setting 3

Select the item.

Select the residual fan operation time period after stopping and the thermo-OFF in cooling mode.

Residual fan operation not performed.

0.5 hours

2 hours

6 hours

*Residual time may vary.

②⑤ Keep fan operating after heating is stopped

Keep fan operating after heating is stopped

No setting

Setting 1

Setting 2

Setting 3

Select the item.

Select the residual fan operation time period after stopping and the thermo-OFF in heating mode.

Residual fan operation not performed.

0.5 hours

2 hours

6 hours

②⑥ Intermittent fan operation in heating

Intermittent fan operation in heating

Stop

Stop for 20 min & run for 5 min

Stop for 5 min & run for 5 min

Select the item.

Select the fan control after the residual fan operation following stop and thermo-OFF in heating mode.

Intermittent fan operation is not done.

Check the operating conditions at every 25 min and run the fan for 5 min.

Check the operating conditions at every 10 min and run the fan for 5 min.

②⑦ Fan circulator operation

Fan circulator operation

Disable

Enable

Select the item.

Set this when operating the fan as a circulator.

During the fan operation, the fan runs continuously.

During the fan operation, the fan runs and stops based on the difference between temperatures detected with the R/C sensor and the return air sensor.

②⑧ Control pressure adjust

Control pressure adjust

Standard

Type1

Select the item.

Set the control pressure when connecting the outdoor air conditioning unit to the Multi (KX) System.

Normal

When all operating IUs are in this mode, the control pressure value is changed.

29 Auto operation mode

Auto operation mode

Auto rule selection ← 30

Auto 1 details ← 31

Auto 2 details ← 32

Auto 3 details ← 33

Back

Select the item.

30 Auto rule selection

Auto rule selection

Auto 1

Auto 2

Auto 3

Back

Select the item.

- Auto 1** The temp difference between the set temp and the actual room temp switch cooling and heating.
- Auto 2** The temp difference between the set temp and the actual room temp/outdoor temp switch cooling and heating.
- Auto 3** The actual room temp and outdoor temp switch cooling and heating.

The method of switching between cooling and heating in the auto operation mode can be selected from three options. Set the condition for each method.

31 Auto 1 details

Auto 1 details

Temp switching to cooling ← 34

Temp switching to heating ← 35

Back

Select the item.

[Set temp - Temp switching to cooling] < [Indoor return air temp]
⇒ Operation mode: Cooling

[Set temp + Temp switching to heating] > [Indoor return air temp]
⇒ Operation mode: Heating

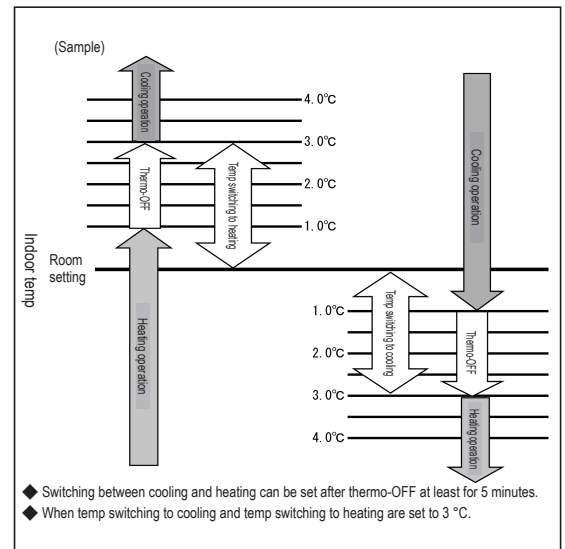

Set the temperatures switching to cooling and heating. Switching temperatures can be set within the range of 1°C to 4°C.

32 Auto 2 details

Auto 2 details

Temp switching to cooling ← 34

Temp switching to heating ← 35

Outdoor temp setting to limit in cooling ← 36

Outdoor temp setting to limit in heating ← 37

Back

Select the item.

“[Set temp - Temp switching to cooling] < [Indoor return air temp]” and “[Outdoor temp, cooling] < [Outdoor air temp]”
⇒ Operation mode: Cooling

“[Set temp - Temp switching to cooling] > [Indoor return air temp]” and “[Outdoor temp, cooling] > [Outdoor air temp]”
⇒ Operation mode: Heating

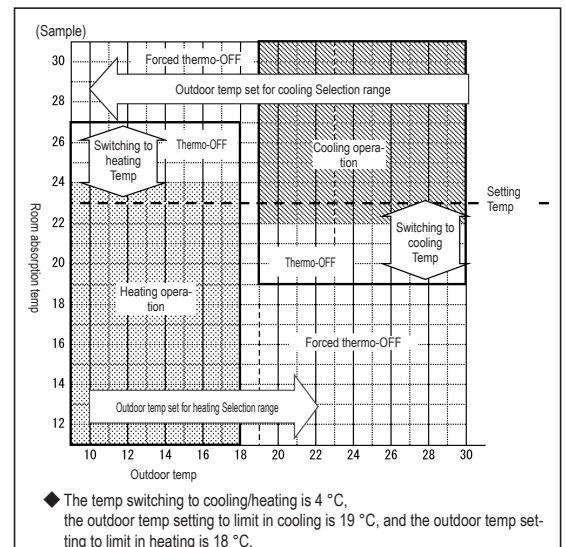

Set the temperatures switching to cooling and heating and the outdoor temp settings to limit in cooling and heating.

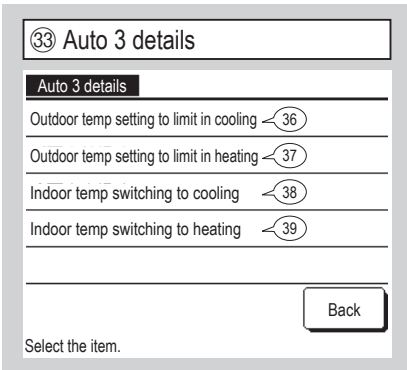

Set the outdoor temp settings to limit in cooling and heating and the indoor temp settings to limit in cooling and heating.

“[Indoor temp, cooling] < [Indoor return air temp]” and “[Outdoor temp, cooling] < [Outdoor air temp]”
 ⇒ Operation mode: Cooling

“[Indoor temp, heating] > [Indoor return air temp]” and “[Outdoor temp, heating] > [Outdoor air temp]”
 ⇒ Operation mode: Heating

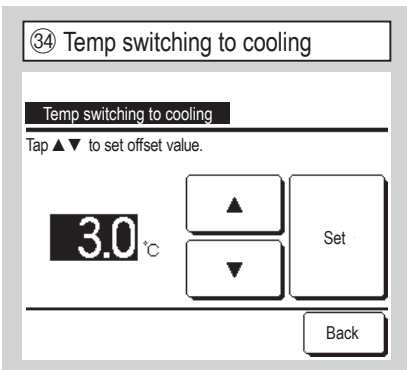
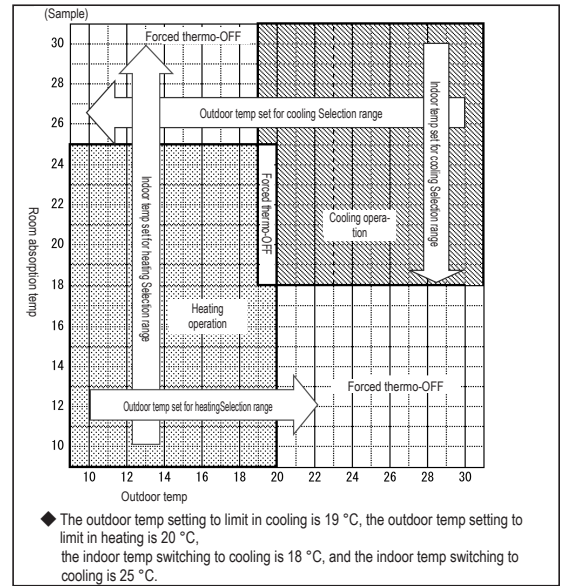

Set the temperature switching to cooling with Auto 1 and Auto 2. The temperature can be set within the range of 1 to 4 °C.

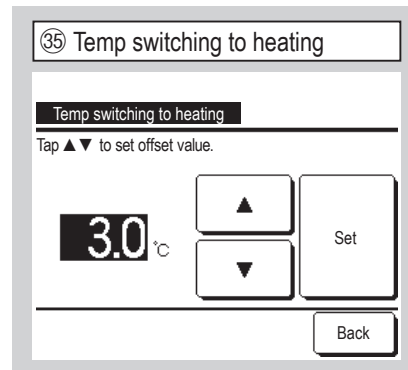

Set the temperature switching to heating with Auto 1 and Auto 2. The temperature can be set within the range of 1 to 4 °C.

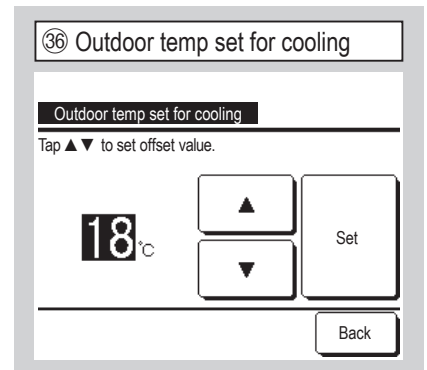

Set the outdoor temperature for cooling with Auto 2 and Auto 3. The temperature can be set within the range of 10 to 30 °C.

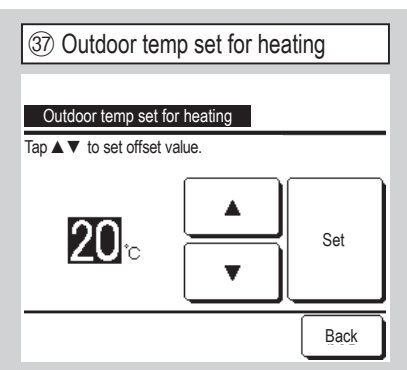

Set the outdoor temperature for heating with Auto 2 and Auto 3. The temperature can be set within the range of 10 to 22 °C.

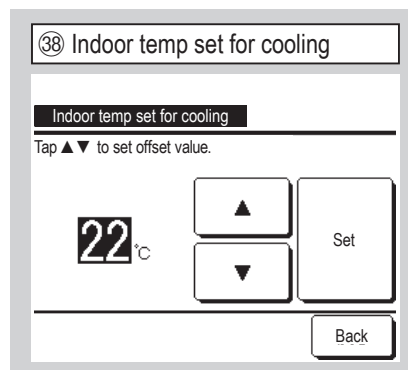

Set the indoor temperature for cooling with Auto 3. Indoor temp, cooling: Can be set within the range of 18°C to 30°C.

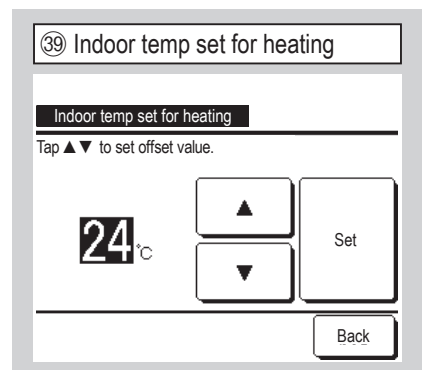

Set the indoor temperature for heating with Auto 3. The temperature can be set within the range of 10 to 30 °C.

④⑩ Thermo. rule setting

Thermo. rule setting

Standard/Outdoor temp basis ④①

Cooling offset ④②

Heating offset ④③

Back

Select the item.

④① Standard/Outdoor temp basis

Standard/Outdoor temp basis

Standard

Outdoor temp basis

Back

Select the item.

Set the room temperature control, thermostat ON/OFF switching method and condition.

Standard The thermostat judges based on the indoor temperature and set temperature.

Outdoor temp basis The thermostat judges based on the outdoor temperature and the cooling and heating offset values.

The room temperature setting will be disabled.

④② Cooling offset

Cooling offset

It is effective only when "Outdoor temp basis" is selected for thermostat control.

2°C

▲

▼

Set

Back

④③ Heating offset

Heating offset

It is effective only when "Outdoor temp basis" is selected for thermostat control.

3°C

▲

▼

Set

Back

④④ Auto fan speed control

Auto fan speed control

Auto 1

Auto 2

Back

Select the item.

The thermostat judges based on the outdoor temperature and the cooling and heating offset values.

(a) Cooling offset: The thermostat judges based on [Outdoor temp - Cooling offset value] during cooling.

The thermostat trips ON when [Indoor temp] > [Outdoor temp - Cooling offset value].

This value can be set in the range of 0°C to 10°C.

(b) Heating offset: The thermostat judges based on [Outdoor temp + Cooling offset value] during heating.

The thermostat trips ON when [Indoor temp] < [Outdoor temp + Cooling offset value].

This value can be set in the range of 0°C to 5°C.

Set the switching range of the fan tap at the auto fan speed setting.

Auto 1 The fan tap is changed in the range of High ⇒ Medium ⇒ Low.

Auto 2 The fan tap is changed in the range of Powerful high ⇒ High ⇒ Medium ⇒ Low.

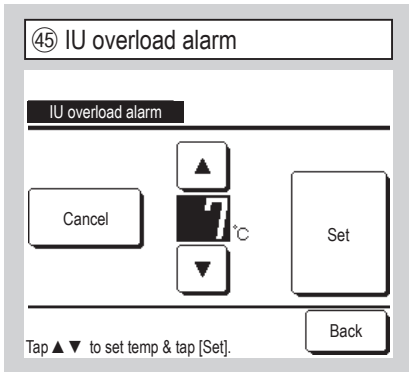

When the room temperature differs to some extent from the setting temperature at 30 minutes after the start of operation, the overload alarm signal is transmitted from the external output (CNT-5).

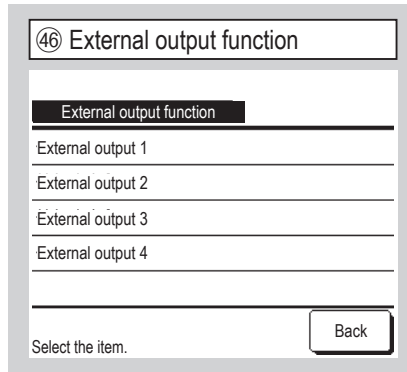

Select the output destination to change and then select the function to be allocated to the selected output.

The following shows output connectors and defaults.

- External output 1 CNT -2 Operation output
- External output 2 CNT -3 Heating output
- External output 3 CNT -4 Compressor ON output
- External output 4 CNT -5 Inspection (Error) output

Refer to the engineering data for details.

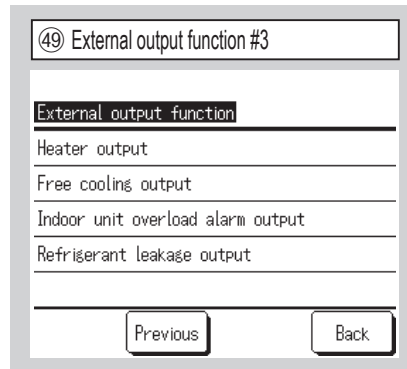
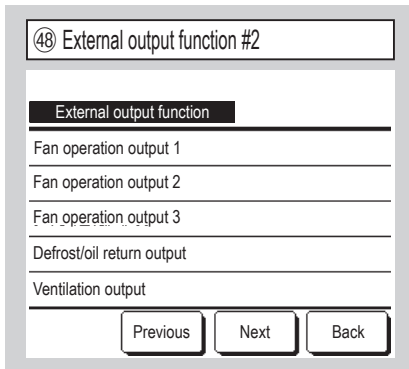
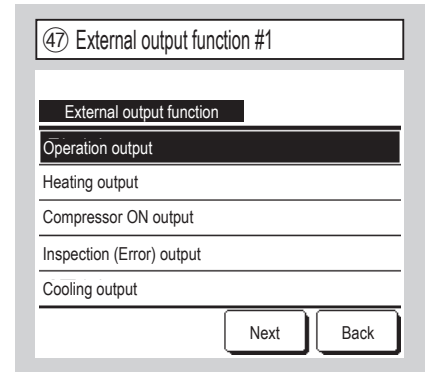

12. Service & Maintenance

TOP screen ⇒ ⇒ ⇒

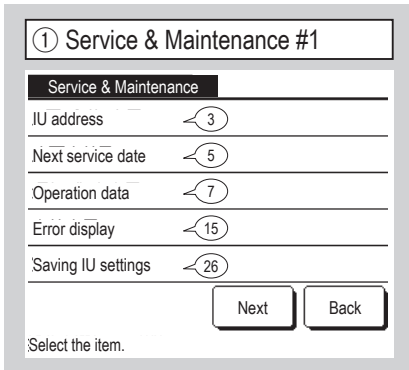

The selected screen is displayed.

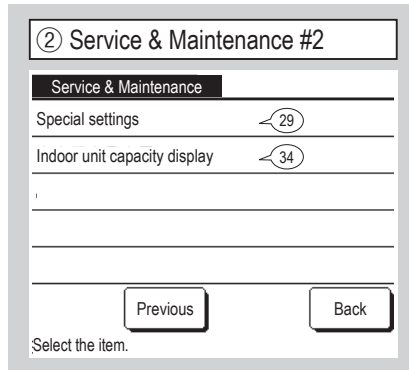

The selected screen is displayed.

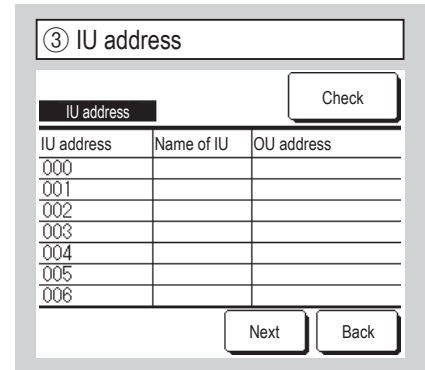

When 8 or more units are connected, further data are displayed on the next page. When the button is tapped after selecting an IU address, the fan of the selected IU can be operated. ⇒④

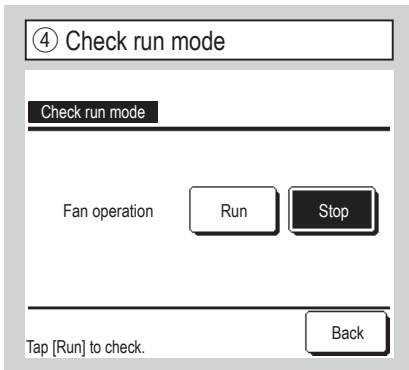

Tap this button to start the fan operation.

Tap this button to stop the fan operation.

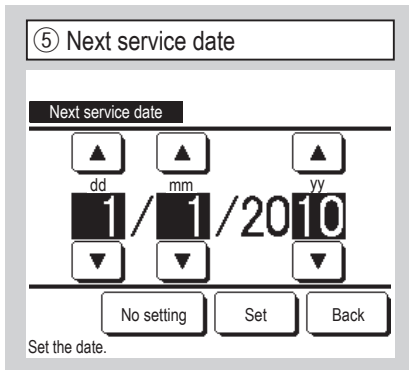

When next service date is entered, messages are displayed at the start/stop of operation on the service month.

Contents are reset if the next service date is updated.

If the button is tapped, messages are not displayed.

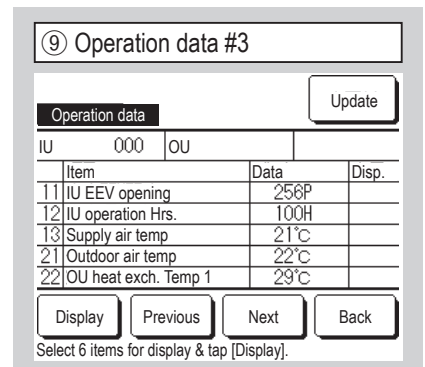
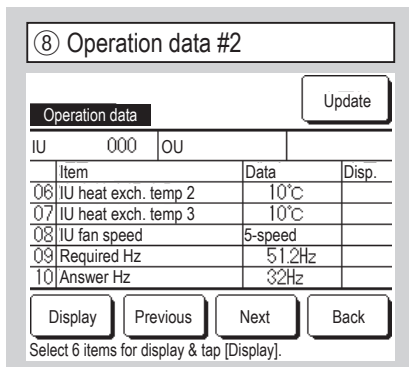
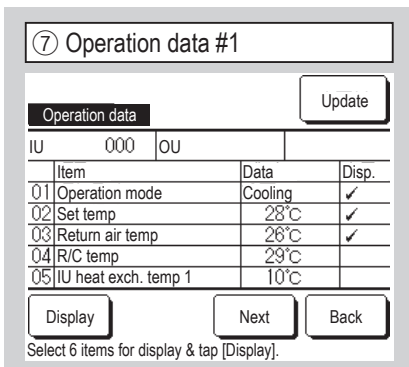
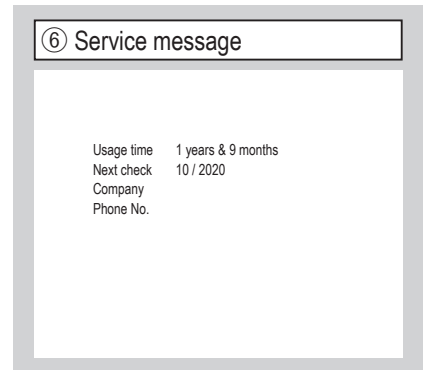

After read the indoor unit data, the operation data at the time of reading are displayed. Tapping the button to update the data. To automatically update data and display, up to six items can be selected. Tapping the button after selecting six items changes the display to ⑭ .

⑩ Operation data #4

Operation data Update

Item	Data	Disp.
23	OU heat exch. Temp 2	29°C
24	Compressor Hz	51.2Hz
25	High pressure	1.2MPa
26	Low pressure	0.20MPa
27	Discharge pipe temp	78°C

Display Previous Next Back

Select 6 items for display & tap [Display].

⑪ Operation data #5

Operation data Update

Item	Data	Disp.
28	Comp bottom temp	27°C
29	Current	8A
30	SH control	48°C
31	SH	48°C
32	TDSH	48°C

Display Previous Next Back

Select 6 items for display & tap [Display].

⑫ Operation data #6

Operation data Update

Item	Data	Disp.
33	Protection control	No. 1
34	OU fan speed	5-speed
35	63H1	ON
36	Defrost	ON
37	Comp. running Hrs	100H

Display Previous Next Back

Select 6 items for display & tap [Display].

⑬ Operation data #7

Operation data Update

Item	Data	Disp.
38	OU EEV 1 opening	512P
39	OU EEV 2 opening	512P

Display Previous Back

Select 6 items for display & tap [Display].

⑭ Individual display

Operation data

Operation mode	Cooling
Set temp	28°C
Return air temp	29°C
R/C temp	28°C
IU heat exch. temp 1	10°C
IU heat exch. temp 2	15°C

Back

⑮ Error display

Error display

Error history	⑩⑯
Display anomaly data	⑩⑰
Erase anomaly data	⑩⑳
Reset periodical check	⑩㉑

Back

Select the item.

Automatically updates and displays the six selected items.

⑯ Error history (Sample)

Error history Delete

Time	IU	ErrorCode
2011/01/19 6:57 PM	014	E16
2011/01/19 6:57 PM	015	E15
2011/01/19 6:57 PM	012	E14

Back

Date and time when error occurred, IU address and Error Code are displayed. Tap the Delete button to delete the error history.

⑰ Display anomaly data #1

Display anomaly data

Item	Data
01	Operation mode Cooling
02	Set temp 28°C
03	Return air temp 26°C
05	IU heat exch. temp 1 10°C
06	IU heat exch. temp 2 10°C

Next Back

⑱ Display anomaly data #2

Display anomaly data

Item	Data
07	IU heat exch. temp 3 10°C
08	IU fan speed 5-speed
09	Required Hz 51.2Hz
10	Answer Hz 32Hz
11	IU EEV opening 256P

Previous Next Back

The operation data obtained just before the occurrence of an error are displayed.

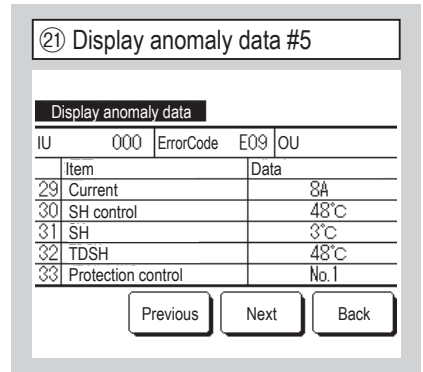
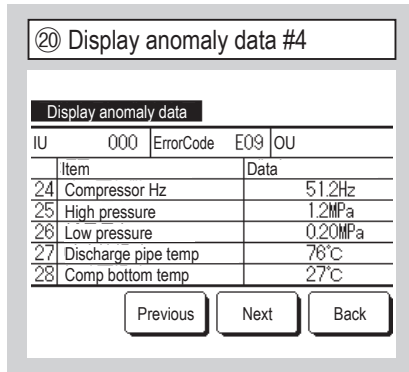
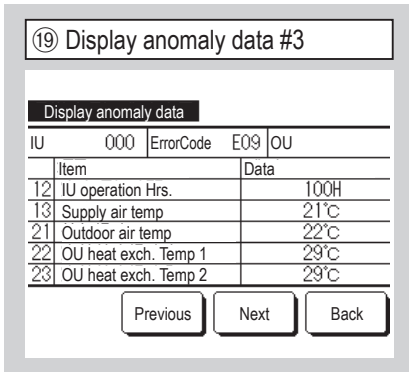

The operation data obtained just before the occurrence of an error are displayed.

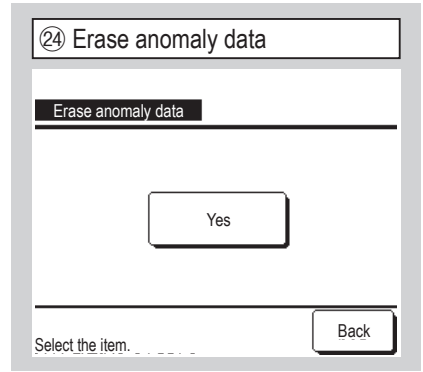
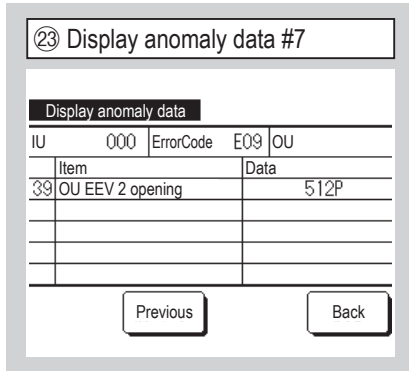
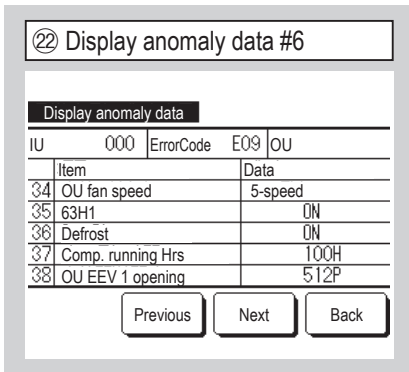

The anomaly data is erased.

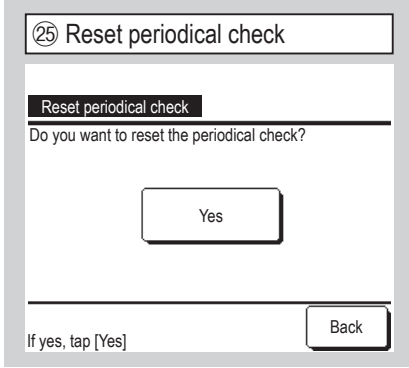

The time count is reset by resetting the periodical check.

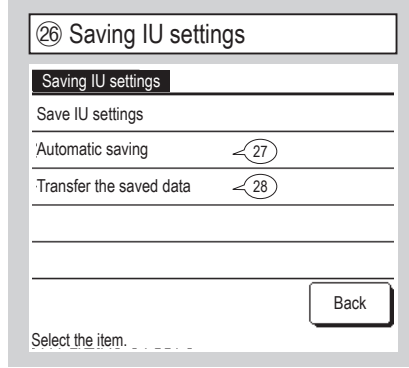

Save IU settings All settings of the IUs connected to the R/C are saved in the R/C.

Automatic saving Set the time when the automatic saving is performed everyday.

Transfer the saved data The IU setting data saved in the R/C are transferred to an indoor unit.

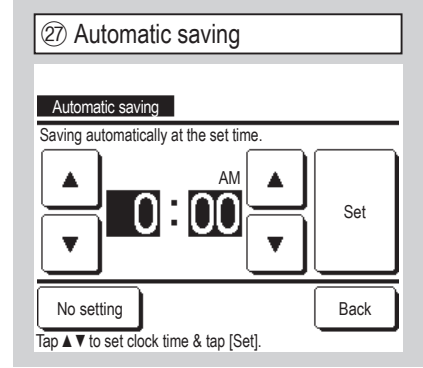

Set the time when the automatic saving is performed everyday.

If the **No setting** button is tapped, the automatic saving is not performed.

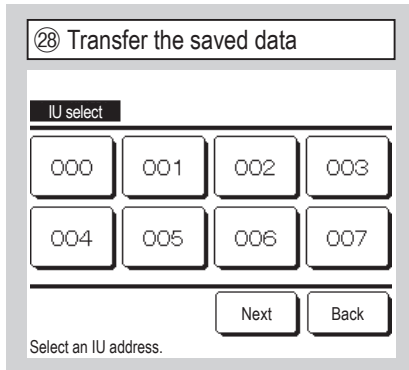

If an IU to which the saved date is transferred is selected, the Transfer the saved data acknowledge screen is displayed. Tap [Yes] to transfer the data.

Advice
Have you ever lost setting contents after replacing an IU board?
When IU settings are saved in the R/C, the saved data can be written to IU using "Transfer the saved data".

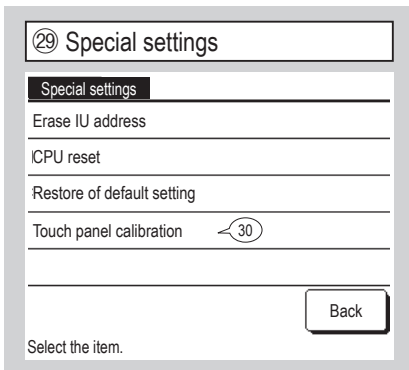

The selected screen is displayed.

- Erase IU address Memory of the IU address for multi (KX) unit is erased.
- CPU reset Microcomputers of IU and OU connected are reset (State of restoration after power failure).
- Restore of default setting Settings on R/C and IU connected are initialized (State of factory default).
- Touch panel calibration Use this to correct when the display and the touch position are not matched.

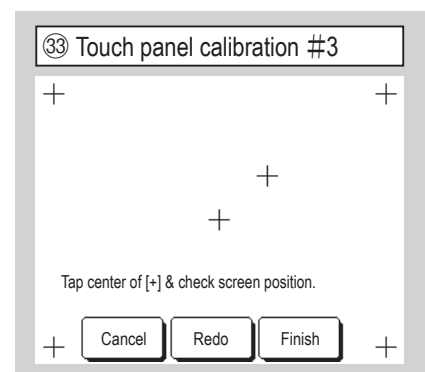
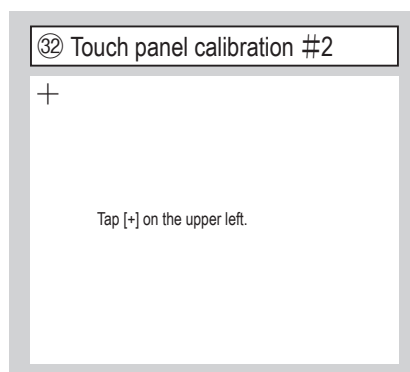
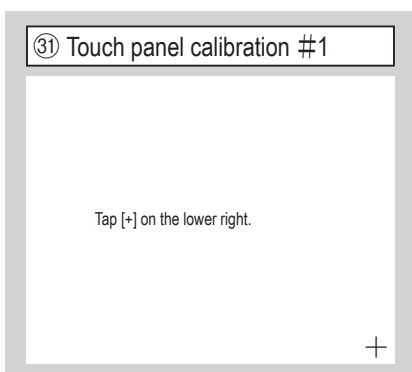
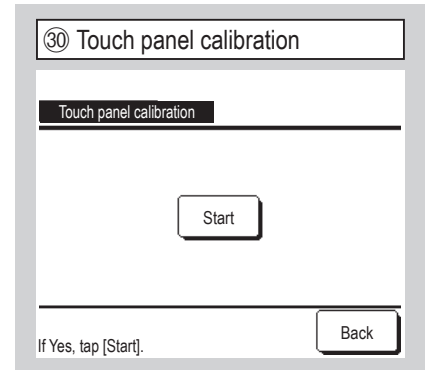

Use this when the display and the touch position are not matched.

Tap the center of [+] and check the deviation from the display.

⇒ Calibration is completed.

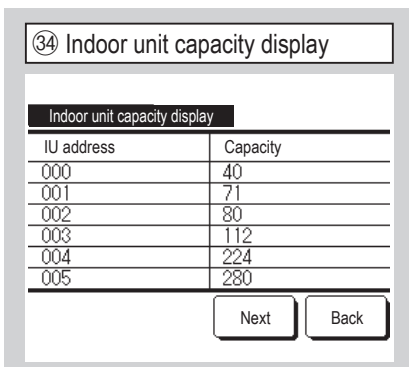

Capacities of IUs connected to the R/C are displayed.

When seven units or more are connected, tap the button to view all.

These items may not be displayed depending on the combination of IUs and OUs.

13. Select the language

[Selecting the language with the button]



Tap the  button on the TOP screen while the air conditioner is stopped.

■ Depending on how the Permission/Prohibition setting (Refer to user's manual) is set, the administrator password input screen may be displayed.

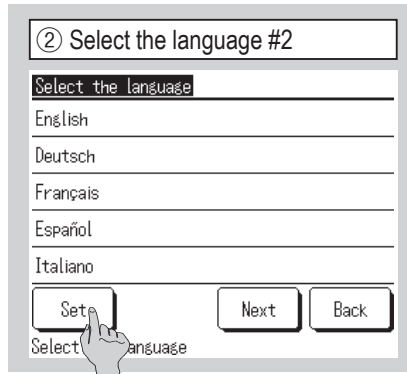

The menu for select the language is displayed. Select the language to be displayed on the R/C and tap the button. You can select from the following languages: English/German/French/Spanish/Italian/Dutch/Turkish/Portuguese/Russian/Polish/Japanese/Chinese

[Selecting the language with the button]

TOP screen ⇒ ⇒



The menu for select the language is displayed.

Select the language to be displayed on the R/C and tap the button.

You can select from the following languages:

English/German/French/Spanish/Italian/Dutch/Turkish/Portuguese/Russian/Polish/Japanese/Chinese